

APPLICATIONS MANUAL  
FOR  
PORTABLE MAGNETOMETERS

**by**  
**S. BREINER**

Geometrics  
2190 Fortune Drive  
San Jose, California 95131  
U.S.A.

Copyright 1999 by Geometrics. All Rights Reserved . Printed in the  
United States of America. This publication, or parts thereof, may not be  
reproduced in any form without permission of Geometrics.

# PREFACE

This Manual was written to satisfy most of the needs of the average user of a portable total field magnetometer for both conventional and unconventional applications, including geological exploration, search for lost objects, magnetic measurements of rock or iron specimens and archaeological prospecting. As the name implies, this is a manual or guide for professional and non-professional persons who may not have the time, the requisite background or the ready access to the proper libraries to delve deeply into standard texts, the few that there are, on applied geophysics.

Some of the information that I have included in this Manual may be found in the references cited or drawn from obscure sources, or uncovered amongst equations and confusing terminology in physics or engineering texts. Many of the facts and instructions in this Manual, however, do not appear anywhere else in print. For example, I know of no other readily available reference on the subjects of magnetic search of buried objects, many of the portable gradiometer applications, operational considerations of proton magnetometers and the effect of electrical currents on portable total field magnetometers. Among the less common subjects that are covered are the magnetic properties and detection of common steel objects, facts concerning the detection of buried ruins, methods for sketch-it-yourself anomaly construction, and some help in interpreting anomalies at the magnetic equator. I also tried to simplify some aspects of the potentially complex subject of magnetism using short-cuts wherever possible and deskilling somewhat the fine art of magnetic interpretation. For most portable magnetometer work, I feel this approach is quite adequate. Certainly for the more sophisticated techniques required for interpretation of the usually-more-precise aeromagnetic surveys, the reader is advised to consult the References or persons knowledgeable in the subject.

Figures and examples are used liberally in the explanations because I feel they assist or confirm one's understanding of these subjects. Almost all of the profiles were drawn free-hand according to the techniques described and should not be considered as precise computer-derived curves. They do demonstrate that one can be his own 'magnetics expert' insofar as what is required for most of these applications.

The question of units always arises in any technical publication. Many magnetic measurements, particularly magnetic properties of rocks and geophysical research, use cgs, some physics and engineering applications use mks, while geophysical exploration, for most of the readers of this Manual, still utilizes feet and miles. A mixture of units, hopefully not too confusing, was therefore unavoidable. Subsequent editions of this Manual may be written specifically in carefully selected metric units.

The various chapters were prepared to be read or utilized independent of each other if necessary. For example, someone interested in using the magnetometer for archaeology but who does not particularly enjoy wading through the mathematics of Chapter V, can proceed directly to Chapter VII. He would be aided, however, by subsequently skimming through Chapter V.

I would appreciate criticism or suggestions should anyone note errors or have suggestions on how I may improve later editions. Moreover, if the reader finds that my explanations or facts fall just short of what is required, I am available by telephone or through written correspondence.

SHELDON BREINER  
GeoMetrics

395 Java Drive  
Sunnyvale, California 94066  
Telephone: (408) 734-4616

# Contents

Preface.....	ii	i	Simplified Method for Total Field Signature. . .	19
<b>I INTRODUCTION</b>			Earth's Field Component Behavior .....	20
.....		1	Dipoles Vs. Monopoles	
<b>II MAGNETOMETERS</b>			Vs. Arrays of Poles .....	20
Instrument Use .....	3		Configuration of Field Lines .....	20
Proton Magnetometer .....	3		Dipole and Monopole Fall-Off Factor .....	20
Total Field Measurement .....	3		Dipole Factor-of-Two .....	20
Limitations of a Proton Magnetometer .....	4		Application of Method .....	20
<b>III EARTH'S FIELD MAGNETISM</b>			Contour Presentation of	
Introduction .....			Dipole and Prism Anomalies .....	22
Time Variations .....	6		Anomaly Amplitude .....	24
Magnetic Minerals and Iron .....	6		Amplitude Estimates	
Induced Magnetization .....	8		for Common Sources .....	24
Remanent or Permanent Magnetization .....	8		Dipole and Monopole Signatures	
<b>IV FIELD PROCEDURES</b>			in Vertical and Horizontal Fields .....	24
<b>AND DATA REDUCTION</b>			Maximum Amplitude Given	
Magnetic Cleanliness and Sensor Positions. . .	11		Magnetization and Generalized Form ...	26
Operational Considerations .....	11		Anomaly Depth Characteristics .....	28
Valid Reading Vs. Noise .....	11		Anomaly Width .....	28
Sensor Orientation .....	12		Anomaly Depth Estimation .....	28
instrument Readings .....	12		Identification of Anomaly .....	29
Correction for Time Variations .....	12		Fall-Off Rate .....	29
High Magnetic Gradients .....	13		Assumptions on Maximum	
Data Reduction .....	13		Amplitude and Depth Estimates .....	29
Profile Smoothing .....	13		Half Width Rules .....	31
Removal of Regional Gradients .....	14		Slope Techniques .....	31
Contour Maps .....	14		Other Depth Estimating Methods .....	31
Construction of a Contour Map .....	15		Interpretation Summary .....	32
<b>V INTERPRETATION</b>			<b>VI MAGNETIC SUSCEPTIBILITY,</b>	
Introduction .....	17		<b>MAGNETIZATION AND MAGNETIC</b>	
Asymmetry .....	17		<b>MOMENT MEASUREMENTS</b>	
Depth Dependence. ....	18		Introduction .....	33
Other Anomaly Shape Factors .....	18		Applications .....	33
Geological Models .....	18		Procedures .....	34
Elementary Dipoles and Monopoles .....	18		Random Sample Rotation	
			for Magnitude Only .....	34
			Systematic Rotation	
			for Magnitude and Direction .....	35
			Dipole in Earth's Field .....	36
			Non-Spherical Object Rotation .....	36

(continued)

## Contents *(continued)*

---

<b>VII</b>	<b>MAGNETIC SEARCH</b>	
	Introduction .....	39
	Determination of Object Magnetism .....	39
	Detectability .....	39
	Magnetic Anomaly Signatures .....	39
	Depth/Amplitude Behavior .....	39
	Search Procedures.....	4 1
	Determination of Magnetic Moment	
	Vs. Search Grid Vs. Resolution .....	41
	Traverses.....	4 1
	Detailed Mapping	
	for Pinpointing Location .....	41
	Special Search Topics .....	42
	Iron and Steel .....	42
	Permanent Vs.	
	Induced Anomaly Sources .....	42
	Pipelines (horizontal) .....	44
	Magnetic Markers .....	44
	Archaeological Exploration .....	45
	Introduction .....	45
	Magnetic Anomalies	
	of Archaeological Origin .....	45
	Remanent Magnetization .....	46
	Archaeomagnetism .....	46
	Magnetization and	
	Susceptibility of Soils .....	46
	Remanent Magnetization of Soils .....	47
	Magnetic Anomaly Complexity .....	47
	Archeological Survey Planning	
	and Feasibility .....	47
	Archaeological Anomaly Amplitude	
	and Signatures .....	47
<b>VIII</b>	<b>GRADIOMETERS AND GRADIENT TECHNIQUES</b>	
	Introduction .....	49
	Applications of the Gradiometer .....	49
	Conditions for Gradient Measurement .....	49
	Gradiometer Sensitivity .....	50
	Gradiometer Readings in the Field .....	50
	Gradiometer as a Filter .....	50
	Calculation of Vertical Gradient .....	51
	Depth Estimates from Vertical Gradients .....	52
	General Expression Involving	
	Gradients and Coordinates .....	53
	Gradient Vector Diagrams and	
	Vector Information from Total Field .....	54
<b>IX</b>	<b>MAGNETIC MEASUREMENTS OF</b>	
	<b>ELECTRIC CURRENT DISTRIBUTIONS</b>	
	Introduction .....	55
	Applications .....	55
	Configuration of Magnetic Field of	
	Electric Current Sources .....	55
	Amplitude of Fields of Current Sources .....	56
	REFERENCES .....	58

# I.

## INTRODUCTION

This Manual is intended for use as a general guide for a number of very diverse applications of portable magnetometers, especially the total field proton (nuclear precession) magnetometers. The diversity of applications and the general complexity of magnetic field measurements limits the depth to which any one subject can be covered, but further information, if desired, can be obtained through the author or from any of the references cited.

Among the applications for which this Manual is written are mineral and petroleum exploration, geological mapping, search for buried or sunken objects, magnetic field mapping, geophysical research, magnetic observatory use, measurement of magnetic properties of rocks or ferromagnetic objects, paleomagnetism, archaeological prospecting, conductivity mapping, gradiometer surveying, and magnetic modeling. The terminology, units of measurement, and assumed prerequisite knowledge are those employed in the field of geology and geophysics.

## II. MAGNETOMETERS

### Instrument Use

The common types of portable magnetometers in use today are fluxgate, proton precession, Schmidt field balance, dip needle and other special purpose instruments. Field balances and dip needles are mechanical devices comprised of pivoted magnets measuring vertical or horizontal intensity or field direction, and are not much used today being replaced by the more sensitive and less cumbersome fluxgate and proton magnetometers. Portable fluxgate magnetometers employ a saturable core sensor held in a vertical direction to measure vertical intensity with an effective sensitivity on the order of several gammas. Fluxgate magnetometers, too, are slowly being replaced by the proton magnetometer which has greater sensitivity (1 gamma or better), absolute accuracy, no moving parts, and measures total field intensity with freedom from orientation errors. For reasons of its increasing utilization and because many applications require these features, the proton magnetometer will be the principal instrument under discussion in the Manual. Much of the Manual from Chapters III through IX nevertheless applies to vertical component flux gate magnetometers as well. Anomaly signatures at high latitudes (magnetic dip 70° or greater) are practically identical for the two instruments; at other latitudes they differ significantly.

### Proton Magnetometer

The proton precession magnetometer is so named because it utilizes the precession of spinning protons or nuclei of the hydrogen atom in a sample of hydrocarbon fluid to measure the total magnetic intensity. The spinning protons in a sample of water, kerosene, alcohol, etc., behave as small, spinning magnetic dipoles. These magnets are temporarily aligned or polarized by application of a uniform magnetic field generated by a current in a coil of wire. When the current is removed, the spin of the protons causes them to precess about the direction of the ambient or earth's magnetic field, much as a spinning top precesses about the gravity field. The precessing protons then generate a small signal in the same coil used to polarize them, a signal whose frequency is

precisely proportional to the total magnetic field intensity and independent of the orientation of the coil, i.e., sensor of the magnetometer. The proportionality constant which relates frequency to field intensity is a well known atomic constant: the gyromagnetic ratio of the proton. The precession frequency, typically 2000 Hz, is measured by modern digital counters as the absolute value of the total magnetic field intensity with an accuracy of 1 gamma, and in special cases 0.1 gamma, in the earth's field of approximately 50,000 gammas.

### Total Field Measurement

The total magnetic field intensity, as measured by a proton magnetometer, is a scalar measurement, or simply the magnitude of the earth's field vector independent of its direction. The measurement can be expressed as in *Figure 1a* as simply the length of the earth's field vector,  $F$ , shown here to be 50,000 gammas. A local perturba-

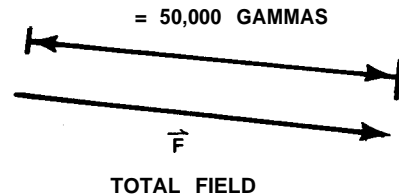

Figure 1a.

tion,  $T$ , of 10 gammas, as might be measured in any of the applications discussed herein, is shown in *Figure 1b* as a vector of arbitrary direction. This disturbance vector adds to the undisturbed field in the usual manner of vector addition as shown in *Figure 1b*, paying special notice to how the figure would actually appear if both the 50,000 and 10 gamma vectors were drawn to scale. It is clear from the figure, then, that since the proton magnetometer measures only the *magnitude* of the resultant vector whose direction is almost exactly parallel

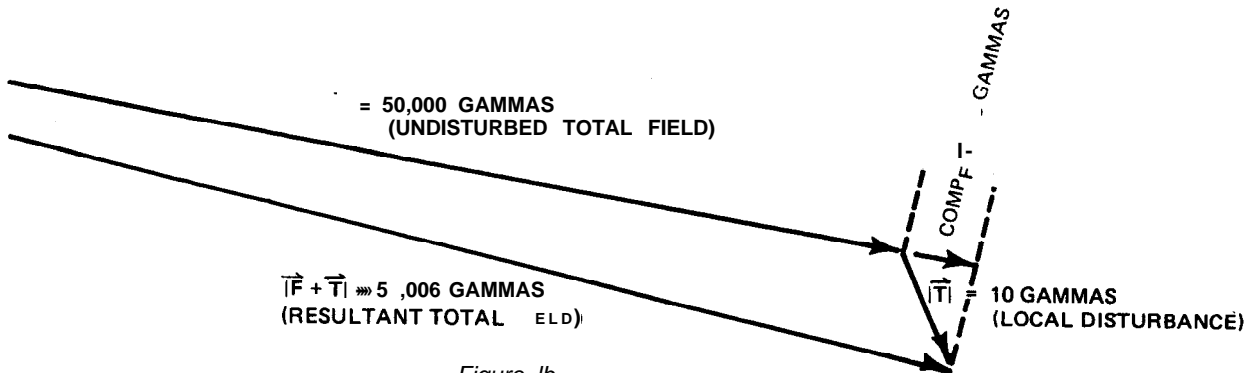

Figure 1b.

to the undisturbed total field vector, that which is measured is very nearly the component of the disturbance vector in the direction of the original undisturbed total field, or where

$$|\vec{F} + \vec{T}| \approx F + \text{comp}_{\vec{F}} T$$

where

$$|\vec{F}| \gg |\vec{T}|.$$

Such conditions are almost always valid except in the near field of large steel objects or in the vicinity of iron ore deposits or certain ultrabasic rocks which produce anomalies larger than 10,000 gammas. Thus, the change in total field,  $\Delta F = \text{comp}_{\vec{F}} T$ , i.e., the component of the anomalous field,  $T$ , in the direction of  $F$ . (Except where noted,  $\text{comp}_{\vec{F}} T$  will be referred to simply as the **anomaly**  $T$ .) The proton precession magnetometer, for small perturbations, can therefore be considered to be an *earth's-field-determined component magnetometer*.

This property of measuring this scalar magnitude of the field, otherwise called total field intensity, is very significant with respect to the asymmetric signatures of anomalies, interpretation of anomalies, and in various special applications. Furthermore, the fact that what is measured is independent of the orientation of the sensor, allows the magnetometer to be operated without attention to orientation or leveling such as would be the case with

a fluxgate magnetometer on the mobile platform of a person, vehicle, or aircraft. The only limitation of such a scalar measurement, albeit a minor one, is the fact that the component of the anomalous field which is measured is not normally under the control of the observer, but rather at the whim of the local direction of the earth's magnetic field.

#### Limitations of a Proton Magnetometer

The proton magnetometer has no moving parts, produces an absolute and relatively high resolution measurement of the field and usually displays the measurement in the form of an unambiguous digital lighted readout. Several operational restrictions exist, however, which may be of concern under special field conditions. First, the proton precession signal is sharply degraded in the presence of a large magnetic field gradient greater than 200 gammas per foot (approximately 600 gammas per meter). Also, the signal amplitude from the sensor is on the order of microvolts and must be measured to an accuracy of 0.04 Hz of the precession frequency of several thousand Hz. This small signal can be rendered immeasurable by the effects of nearby alternating current electrical power sources. For these two reasons, a *proton magnetometer cannot usually be operated within the confines of a typical building*. Developments and procedures are presented which minimize these effects for the applications to be described in the Manual.

### III.

## EARTH'S FIELD MAGNETISM

#### Introduction

The earth's magnetic field resembles the field of a large bar magnet near its center or that due to a uniformly magnetized sphere. The origin of the field is not well understood, but thought to be due to currents in a fluid conductive core. On the surface of the earth the pole of this equivalent bar magnet, nearest the north geographical pole, is actually a 'south' magnetic pole. This paradoxical situation exists since by convention a north-seeking end of a compass needle is defined as pointing north yet must point to a pole of opposite sense or south pole of the earth's magnetic field. To avoid possible confusion, though, the magnetic pole near the geographical north pole is, and will be referred to as, a 'north' pole.

The field, or flux, lines of the earth exhibit the usual pattern common to a small magnet as shown in *Figure 2*. Note that the direction of the field is vertical at the north and south magnetic poles, and horizontal at the magnetic equator. An understanding of this geometry is important with respect to interpretation of magnetic anomalies. The intensity of the field, which is a function of the density of the 'flux lines' shown in *Figure 2*, again behaves as a bar magnet being twice as large in the polar region as in the equatorial region, or approximately 60,000 gammas and 30,000 gammas respectively. The inclination from

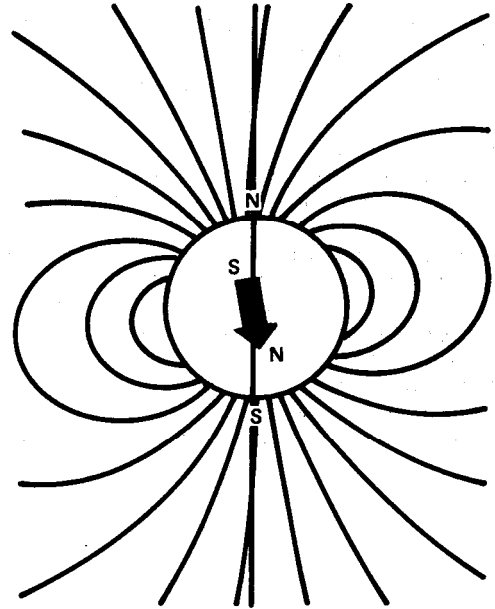

Figure 2.

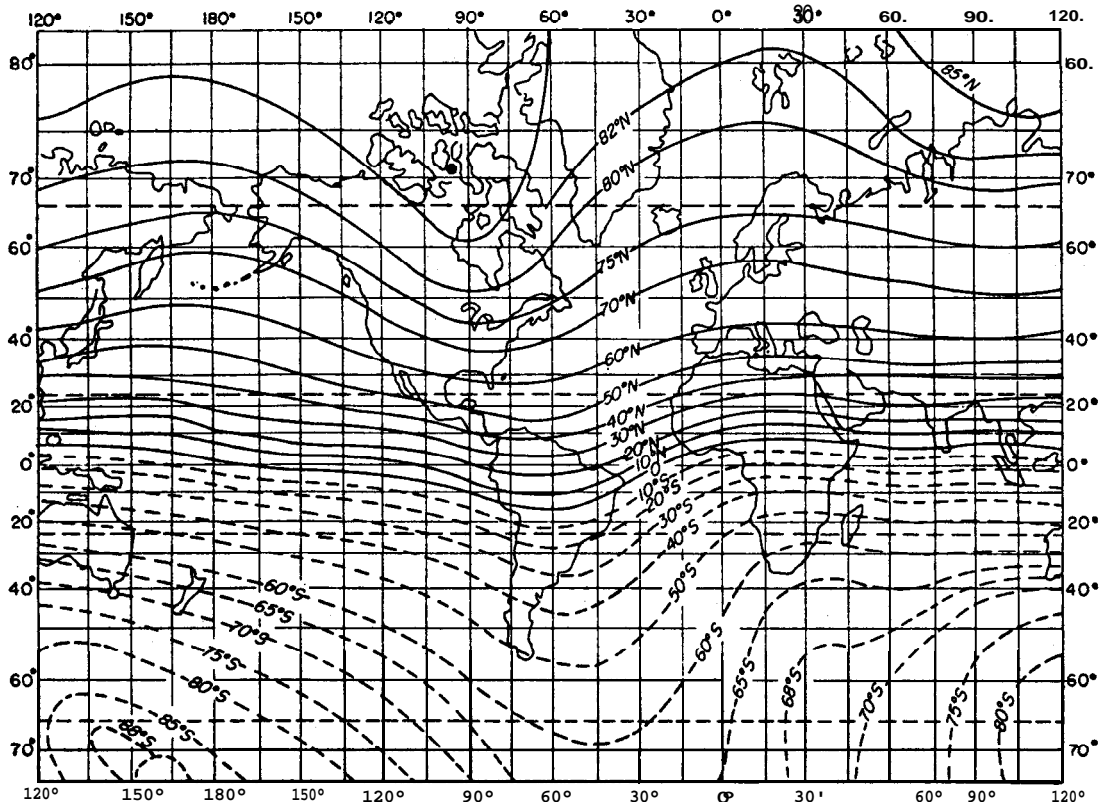

Figure 3. The Geomagnetic Inclination in Degrees of Arc from the Horizontal

SOURCE: U.S.N.H.O



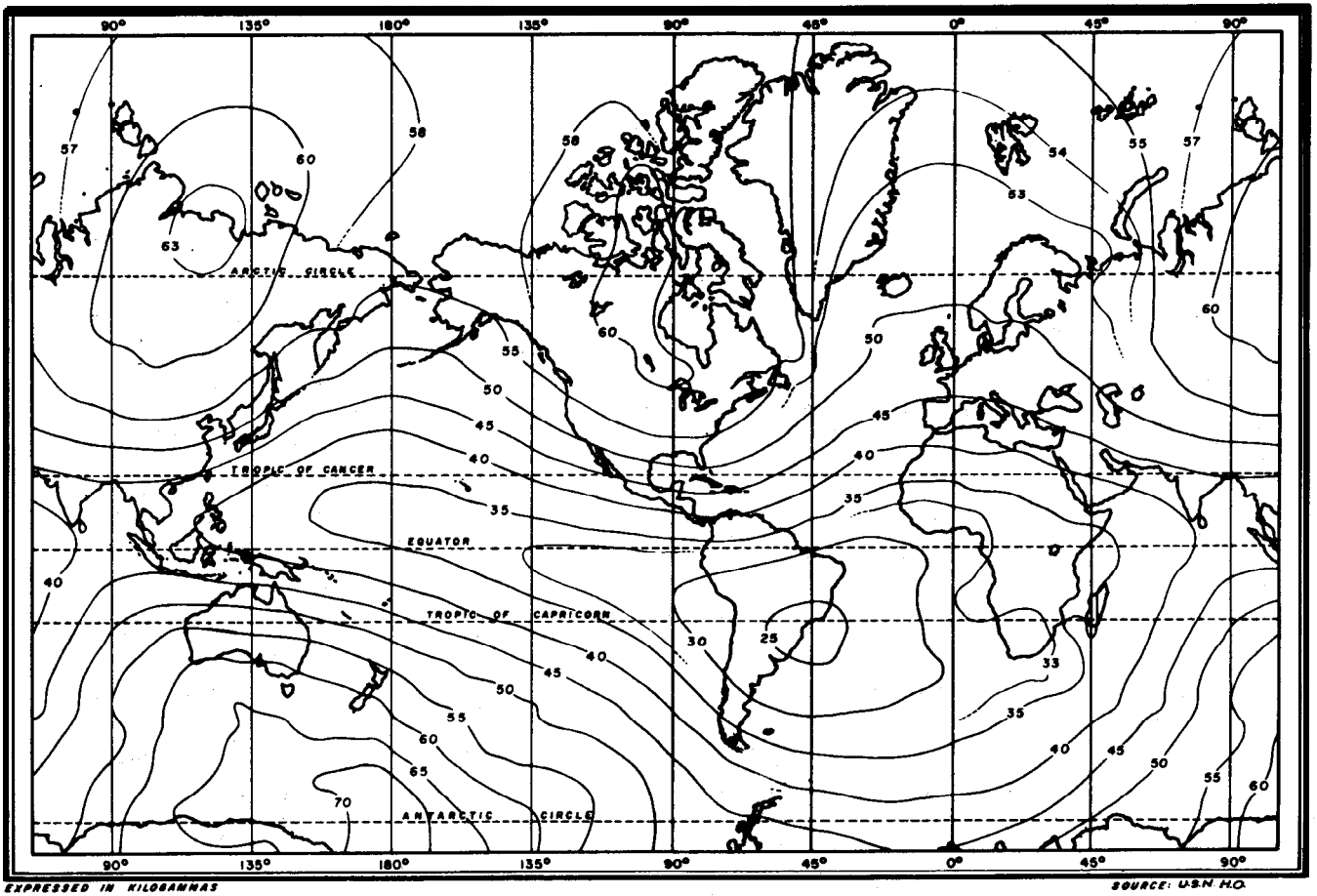

Figure 4. The Total Intensity of the Earth's Magnetic Field

the horizontal and the total intensity are shown in *Figures 3 and 4*. (NOTE: 1 gamma =  $10^{-5}$  gauss. Gauss is actually a unit of magnetic induction and oersted a unit of magnetic intensity-B and I-I respectively, in physics nomenclature. By convention in the geophysical community, however, gauss is the unit in cgs of magnetic intensity. In any event, numerically, 1 gamma =  $10^{-5}$  gauss =  $10^{-5}$  oersted =  $10^{-9}$  webers/M<sup>2</sup> =  $10^{-9}$  tesla.)

The earth's total field intensity is not perfectly symmetric about the geographical north pole. First, the north magnetic pole is in northern Canada more than 1000 miles from the geographical pole (note again *Figure 2*). Also, the earth cannot exactly be represented by a single bar magnet, but has numerous higher order poles and very large-scale anomalous features owing to unknown characteristics of the generating mechanism in the earth's core. In addition, the solar wind or constant flux of particles and electric currents from the sun distort the field lines from what is shown in *Figure 2* to a more or less tear-drop shape with the blunt end towards the sun. The last, but for the purposes of this Manual, most relevant deviation from a symmetric field is the anomalous set of features in the earth's crust caused by local variations in the magnetic minerals or other features of interest which distort the local earth's magnetic field.

#### Time Variations

The variations described above all refer to the spatial variations in the earth's magnetic field, but there are variations in time as well. Significant time variations with periods of seconds, minutes and hours are the direct

or indirect effect of the solar wind referred to above as it distorts the magnetosphere or external magnetic field of the earth. Daily or diurnal variations are primarily seen during the local daylight hours shown for typical days in *Figure 5*. Diurnal variations are not predictable, may exhibit changes as large as 100 gammas or more and are often removed from portable magnetometer data by methods described in Chapter IV. Superimposed upon these diurnal variations are more short-period phenomena called micropulsations (*Figure 6*) which are more random in behavior, generally smaller in amplitude and may occur at any time of the day or night. Micropulsations occur in a broad range of periods between 0.01 seconds up to several tens of minutes with amplitudes from a thousandth of a gamma to several tens of gammas.

Of still greater concern as a possible source of erroneous data are magnetic storms occurring as often as several times per month with their onset suddenly and simultaneously throughout the world. Such storms may exhibit variations of up to several hundred gammas and may last one day or up to several days. (See *figure 7*.) For very important field measurements, particularly for higher resolution measurements, a recording base station or reference monitor is often used which is examined at the start of each day for an indication of magnetic storm activity and also for subsequent removal of the diurnal variations from field data using time as a correlation.

The earth's internal or main field also changes slowly over years, tens and thousands of years through what is termed the secular variation. The inclination, intensity

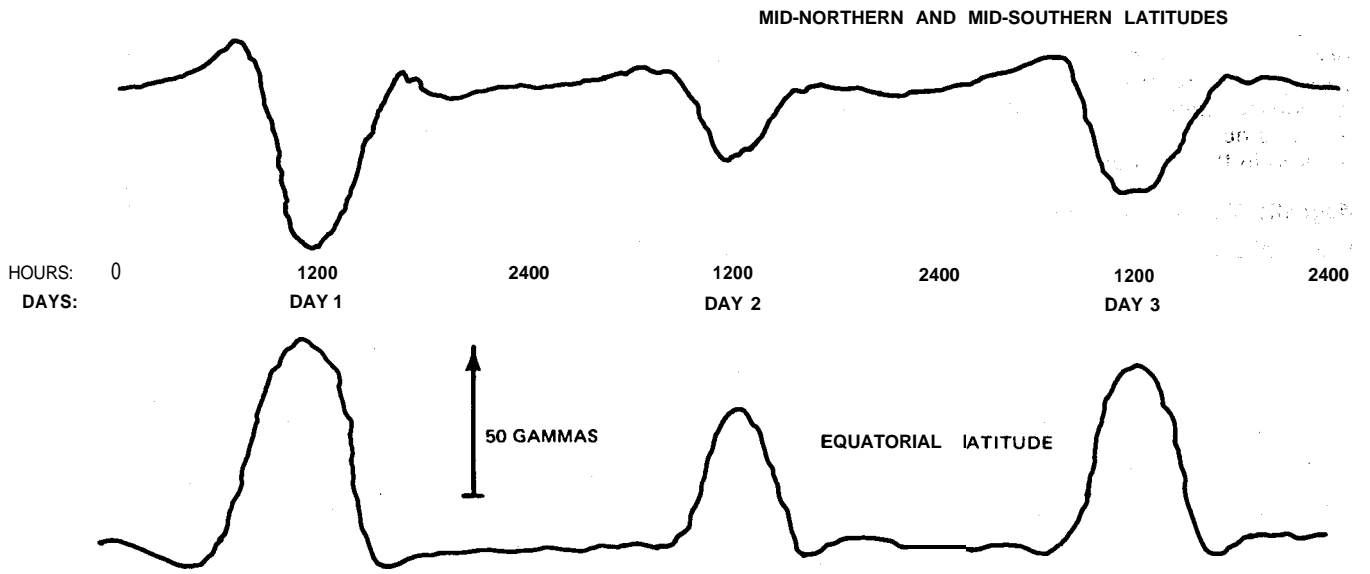

Figure 5. Typical Diurnal Variations in Total Field Intensity

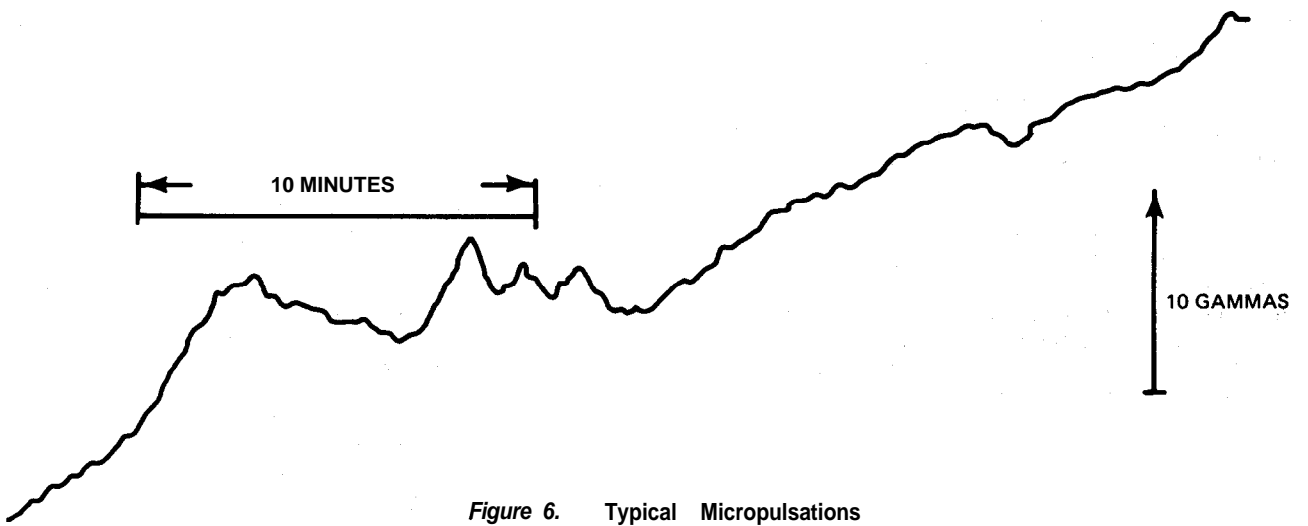

Figure 6. Typical Micropulsations

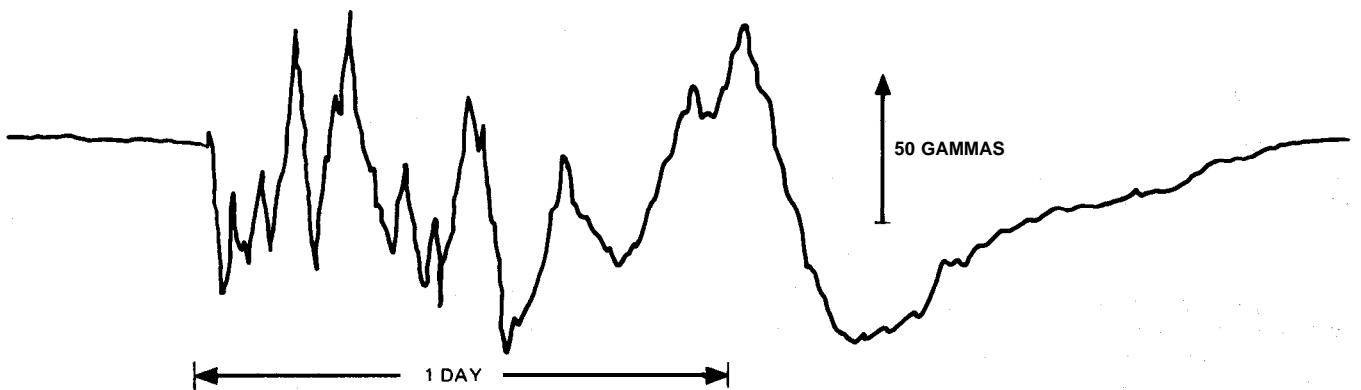

Figure 7. Typical Magnetic Storm

and even the location of the poles varies slowly at a rate relevant, in the context of this Manual, only to observatory and archival interests. From time-to-time through geologic history, the main field has even reversed and the consequences of these events are extremely important for a number of portable magnetometer applications covered in the Manual.

### Magnetic Minerals and Iron

The application of portable magnetometers as treated herein has, as its primary objective, the identification and description of spatial changes in the earth's field. The time changes described above simply represent noise or interference in the measurements of interest. The spatial variations or anomalies to be mapped for these applications are those which might occur over several feet or several thousands of feet and are usually caused by an anomalous distribution of magnetic minerals or by iron objects or cultural features which may be of interest. The anomalies from naturally occurring rocks and minerals are due chiefly to the presence of the most common magnetic mineral, magnetite ( $\text{Fe Fe}_2\text{O}_3$ ), or its related minerals, ulvospinel, titanomagnetite, maghemite, etc. which will collectively be referred to as magnetite, a dark, heavy, hard and resistant mineral. The rust-colored very common forms of iron oxide are not usually magnetic and are seldom related to the source of magnetic anomalies. Other magnetic minerals which occur to a far lesser extent are ilmenite, pyrrhotite (with sulphide mineralization), and others of even lesser consequence.

All rocks contain some magnetite from very small fractions of a percent up to several percent, and even several tens of percent in the case of magnetic iron ore deposits. The distribution of magnetite or certain characteristics of its magnetic properties may be utilized in exploration or mapped for other purposes. Iron objects in the earth's magnetic field, whether something buried or intentionally planted for subsequent retrieval, would also create a detectable magnetic anomaly. Cultural features associated with man's habitation can frequently be detected through magnetic surveys owing to the contrast in magnetite associated with numerous artificial features such as man-made structures, voids, or the enhanced magnetic effects of baked clays and pottery (see Chapter VII).

### Induced Magnetization

Magnetic anomalies in the earth's magnetic field are caused by two different kinds of magnetism: induced and remanent (permanent) magnetization. Induced magnetization refers to the action of the field on the material wherein the ambient field is enhanced and the material itself acts as a magnet. The magnetization of such material is directly proportional to the intensity of the ambient field and to the ability of the material to enhance the local field—a property called magnetic susceptibility. The induced magnetization is equal to the product of the volume magnetic susceptibility,  $k$ , and the earth's or ambient field intensity,  $F$ , or

$$I_i = kF$$

where  $I_i$  is the induced magnetization per unit volume in cgs electromagnetic units, and  $F$  is the field intensity in gauss. (Note: in some texts, the specific magnetic susceptibility or susceptibility per unit weight (gram) is used) For most materials,  $k$  is much less than 1 and, in fact, is usually  $\pm 10^{-6}$  cgs or smaller. If  $k$  is this small and positive, the material is said to be paramagnetic and,

when negative, diamagnetic. For magnetite,  $k$  is approximately 0.3 cgs and is ferrimagnetic while for iron alloys,  $k$  may vary between 1 and 1,000,000 and such materials are called ferromagnetic. Both ferrimagnetic and ferromagnetic susceptibility are also a function of the field intensity in which they are measured. In all cases, in this Manual, the field intensity is assumed to be the ambient earth's field intensity between 0.3 and 0.6 gauss

A parameter similar to  $k$  is the magnetic permeability,  $\mu$ , which is the ratio of the magnetic induction,  $B$ , to the field intensity,  $F$  (Magnetic induction is the magnetization induced in the material).  $B$  includes not only the magnetization of the material, but also the effect of the field itself and is expressed by

$$B = F + 4\pi I$$

where  $B$  is in gauss. Therefore as stated above,

$$\mu = \frac{B}{F}$$

and

$$\mu = 1 + 4\pi k$$

Thus when  $k$  is very small, as in air,  $\mu \approx 1$  and when  $k$  is 0.1 or larger  $\mu$  is generally one order of magnitude larger. The susceptibility  $k$  can be thought of as the absolute ability and  $\mu$  the relative ability of a material to create local magnetization. The measurement of permeability is most often used for materials where  $\mu$  is much greater than 1, typically iron, steel and other ferromagnetic alloys.

Inasmuch as magnetite and its distribution is of such great importance for a number of these applications, it is important to understand its relation to common rock types. The susceptibility  $k$  of magnetite was given as approximately 0.3 cgs which may actually vary between 0.1 and 1.0 depending upon its grain size and other properties. The magnetic susceptibility of a rock containing magnetite is simply related to the amount of magnetite it contains. For example, *rock containing 7% magnetite will have a volume susceptibility of  $3 \times 10^{-3}$  cgs*, etc. Typical susceptibilities of rocks are given below, but may vary by an order of magnitude or more in most cases:

altered ultrabasic rocks	$-10^{-4}$ to $10^{-2}$ cgs
basalt	$-10^{-4}$ to $10^{-3}$
gabbro	$-10^{-4}$
granite	$-10^{-5}$ to $10^{-3}$
andesite	$-10^{-4}$
rhyolite	$-10^{-5}$ to $10^{-4}$
shale	$-10^{-5}$ to $10^{-4}$
shist and other	
metamorphic rocks	$-10^{-4}$ to $10^{-6}$
most sedimentary rocks	$-10^{-6}$ to $10^{-5}$
limestone and chert	$-10^{-6}$

Typically, dark, more basic igneous rocks possess a higher susceptibility than the acid igneous rocks and the latter, in turn, higher than sedimentary rocks.

### Remanent or Permanent Magnetization

The remanent or permanent magnetization,  $I_r$ , (the former ascribed to rocks, the latter to metals) is often the predominant magnetization (relative to the induced magnetization) in many igneous rocks and iron alloys. Permanent magnetization depends upon the metallurgical properties and the thermal, mechanical and magnetic history of

the specimen, and is independent of the field in which it is measured. Magnetite may have a remanent magnetization,  $I_r$ , of perhaps 0.1 to 1.0 gauss, ordinary iron may have a permanent magnetization between 1 and 10, and a permanent magnet may be between 100 and 1,000 gauss or larger. Chapter VI will describe simple methods for measuring both the remanent and induced magnetizations and the magnetic susceptibility of rocks and miscellaneous objects. Chapter VII more fully describes the magnetization of iron objects.

The remanent magnetization is of great importance in mapping and interpretation, and in the fields of paleomagnetism, archaeological exploration, and anetism. The remanent magnetization of magnetite is as stated independent of the present earth's field. By and large, the high values of remanent magnetization are related to the effects of heating, whether naturally heated, as in the case of igneous rocks, or artificially heated, as in the case of baked clay, pottery, and other man-made objects found in archaeological sites. Prior to such heating, small regions, called domains, within each magnetite crystal would be more or less randomly-oriented. During heating, particularly at high temperatures, the

domains reorient themselves, which upon cooling, tend to align themselves more or less in the direction of the ambient magnetic field and thus parallel to each other, thus creating a net magnetization fixed with respect to the object. This remanent magnetization may be as much as 10 or more times greater than the induced magnetization for many rock types. Thus, the net magnetization might be considerably higher than would be indicated merely by consideration of the susceptibilities listed above.

The remanent magnetization of a rock or object may or may not be in the same direction as the present earth's field for the object may have been reoriented and because the earth's field is known to have changed its orientation in geologic and even historic time. Rocks are frequently reversely magnetized so that measurement of this remanent magnetization is a useful aid to interpretation if the rocks which produce an observed anomaly are, indeed, accessible. The fields of paleomagnetism and archaeomagnetism in particular depend upon the precise determination of the orientation of the 'frozen paleo-field' as it is measured in a given rock or other specimen, and methods for measuring such will be described in Chapter VI.

## IV.

# FIELD PROCEDURES AND DATA REDUCTION

### Magnetic Cleanliness and Sensor Positions

Most of the applications for portable magnetometers require that *the operator be relatively free of magnetic materials on his person*. The importance of checking oneself cannot be over-estimated if measurements on the order of 1 gamma are desired. In field surveys, the usual magnetic material one may have may include, of course, the obvious such as a rock pick, Brunton compass, pocket knife, or instrument console and the not-so-obvious effects of the pivot in eyeglasses, the pants clip at the top of men's trousers, the light meter in a camera, the magnet in the speaker of a tape recorder, metal in a clipboard, some mechanical pencils, some keychains, and the steel shank in one's shoes or boots. Of course, some of these items cannot be altered or left behind and some are not significant in any event. The sensor itself should be kept clean to avoid possible contamination by magnetite-bearing dirt on the sensor surface. In order to check the 'heading effect', i.e., the effect of orientation on the observed field intensity during a field survey, the operator can take readings at each of the four cardinal directions while pivoting about the position of the sensor and note the changes. If the maximum change is typically less than 10 gammas, the average readings on a line will probably not be affected by more than 5 gammas and individual readings by less than this inasmuch as readings along the profile are more-or-less along a given heading  $\pm$  perhaps 30" about one orientation. If a sensitivity of 1 gamma is desired, the heading error should be less than several, preferably 2 gammas or less and depending upon the desired sensitivity, the operator should make some effort to face in the same direction, if possible, for all readings on a given traverse.

The sensor for a proton magnetometer may be carried on a 8-foot (2.2 meter) staff, on a backpack, on an extended staff to 12 feet (4 meters) or more as necessary, or by a second person as represented in *Figure 8*. The sensor on an 8-foot staff is by far the most common means for field measurements removing the sensor sufficiently far from the console and from the operator so as not to be much affected by normal items of clothing, etc. The purpose of mounting a sensor on an extended 12 foot or longer staff is to remove the sensor from the

locally disturbing effects of highly magnetic surface materials, such as surface laterite, glacial till, or highly magnetic outcropping rocks. The sensor may also be raised in the case of very high magnetic gradients which would otherwise ruin the magnetometer signal and prevent any reading whatsoever (see following sections). An additional reason for an extended staff will be described in Chapter VIII in reference to vertical gradient measurements. There are also occasional reasons for a second person carrying the sensor while the first person carries the console together, perhaps, with magnetic or other materials that must necessarily be on his person such as pick, tape recorder, another instrument or rock samples.

The sensor may be carried in a backpack pouch for more convenient field operation where 5 or 10 gamma sensitivity is all that is desired, but care should be taken to check the effects of the batteries and console (particularly the very magnetic alkaline batteries). The backpack pouch frees the hands for taking notes, pushing aside the underbrush and, in general, balances the load of the console and decreases fatigue.

### Operational Considerations

#### Valid Readings Vs. Noise

It is important to establish that, in fact, the magnetometer is providing valid readings. The simplest means of confirming that what is being observed is a magnetic field reading and not random, meaningless instrument readings (i.e., noise) is to take several readings in succession in one location without moving anything, and note the repeatability. Successive readings should be within  $\pm 1$  gamma,  $\pm 0.25$  gamma or  $\pm 1$  count for whatever the sensitivity setting. Valid readings should not, under any naturally-occurring circumstances including magnetic storms, vary by as much as\* 10 or f 100 gammas in a few seconds; if such is observed, the readings represent either noise or a degradation of the noise ratio with the observed corresponding loss in terms of sensitivity. Under certain circumstances even successive readings repeating to within several gammas may still represent noise. To confirm that these readings are indeed magnetic field, simply 'kill' the signal by placing,

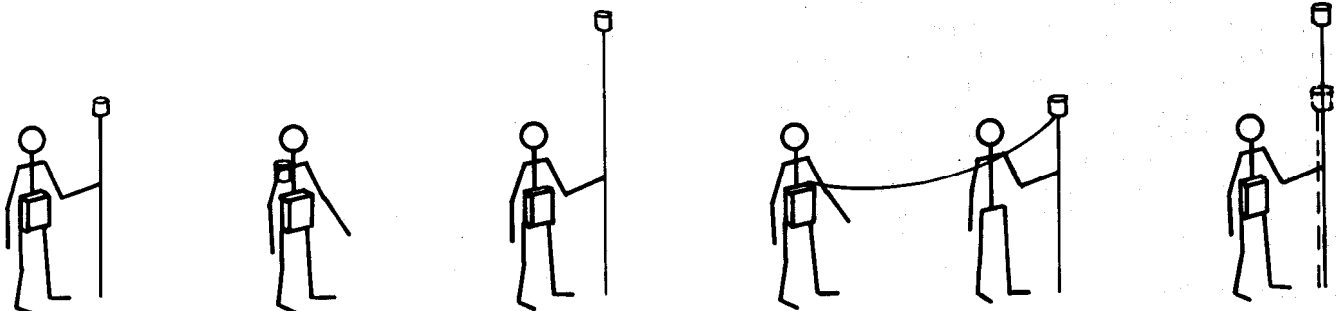

Figure 8. Sensor Carrying Positions

momentarily during the reading, something magnetic adjacent to the sensor such as one's shoe, watch, certain rocks, etc. Random readings varying by 10 or 100 gammas or more would then be observed in addition to their deviating considerably from the readings without the object present. Another but less certain method is to take readings at intervals of increasing distance from an object or location known to produce a magnetic anomaly.

Typical reasons for a proton magnetometer not producing valid readings may be: electrical noise from AC power lines, transformers or other radiating sources; high magnetic gradients from underlying rocks, nearby visible or hidden iron objects, fence lines or improvised iron hardware improperly used near the sensor; improper orientation of the sensor (even when 'omni-directional') expired batteries, incorrect range setting or instrument failures broken or nearly broken sensor cable, and other malfunctions usually described in the instrument operating manual.

Valid but distorted readings may result from several other conditions including the above effects of high magnetic gradients, magnetic dirt or other magnetic contamination on the sensor and any magnetic bias on the operator. Time variations (Chapter III and following) and the effects of direct current in distant power lines and trains (Chapter IX) can also distort magnetic observations.

### Sensor Orientation

According to the theory of operation of the proton magnetometer, the total intensity, measured as the frequency of precession, is independent of the orientation of the sensor. The amplitude of the signal, however, does vary (as  $\sin^2\theta$ ) with the angle between the direction of the applied field within the sensor and the earth's field direction. Variation of signal amplitude does not normally affect the readings unless there is simply insufficient signal to be measured accurately, i.e., a minimum signal amplitude is required above which a variation in amplitude does not affect the readings.

Ideally, the applied field in the sensor should be at right angles to the earth's field direction. The direction of the applied field is governed by the configuration of the polarizing coils in the sensor which are commonly either solenoids (cylindrical) or toroids (ring or doughnut-shaped). The solenoid produces an applied field parallel to its axis, whereas the toroid produces a field which is ring-shaped about the axis of the toroid (consult the instrument operations manual to determine the direction of these axes with respect to the sensor housing). Solenoids are used because they produce somewhat higher signal than a toroid and are less perturbed by electrical noise, whereas a toroid is inherently omnidirectional. In the ideal case, a solenoid should be held horizontal and in any direction in a vertical field, and should be held vertical in a horizontal (equatorial) field for maximum signal amplitude. A toroidal sensor should be held with its axis vertical in a vertical field, and pointing north in an equatorial field to obtain maximum signal. A field which dips greater or less than  $45^\circ$ , should be treated as though it were a vertical or horizontal field respectively.

### Instrument Readings

Measurements are normally made at regular intervals along a grid or otherwise selected path whose locations

are noted for subsequent plotting. Simple pacing is usually adequate with readings every 6, 10, 50, 100, 500, or even 1,000 feet (2 to 300 meters), as anomalies, field, and either geological or search requirements dictate. Traverses may be selected along pathways or other accessible routes and occasional locations noted on an aerial photograph or map using paced distances in between. The density of readings along the traverse should be related to the wavelength of anomalies of interest such that several readings are obtained for any such anomaly. A single trial line with relatively dense stations is usually attempted first to determine the required station density. It is important never to hold the magnetometer sensor within one or two feet of the ground, if possible, in order to avoid effects of minor placer magnetite which usually collects on the surface of the ground, and also to avoid the effects of microtopography or outcropping rock surfaces.

Readings may be noted in a field notebook or, if desired, on a miniature tape recorder, but care must be taken to magnetically compensate the speaker magnet and motor following the theory given in Chapter VI if one is to use a recorder. The convenience of the recorder is that only one hand is needed and the data may be played back for fast, convenient plotting.

### Correction for Time Variations

Some ground magnetic surveys require correction for diurnal and micropulsation time variations. Correction is required if the anomalies of interest are broad (thousands of feet) and typically less than 20 to 50 gammas, or if the profile lines are very long, or if the objective of the survey is a good magnetic contour map expressive of deep-seated anomaly sources. Also, if the survey is performed in the high magnetic latitudes in the auroral zone where typical micropulsations are 10 to 100 gammas, correction for such variations would be necessary. On the other hand, if one is merely interested in profile information of anomalies of several hundred gammas or if the anomalies are only 20 gammas but can be traversed completely in less than 5 minutes, no time variation correction is needed. *Perhaps most surveys fit the latter criteria and do not actually require any such correction for time variations.*

The simplest method of correcting for time variations involves repeated readings in the same orientation at the same station at different times during the survey. If a smooth curve is drawn through the readings plotted as a function of time (every hour or so), these values can be subtracted from all other readings provided that each reading also includes the time at which it was observed. To avoid an extremely long and repeated walk to a single reference station, it is also possible to 'double-back' to take a second or third reading on each given traverse to determine at least the time variations for that traverse. Still another technique is to emulate what is done on aeromagnetic surveys, namely, obtain rapidly acquired measurements on tie lines or lines which cross the principal traverse lines at each end and perhaps in the center. The stations common to each traverse and tie lines should be known and occupied while facing the same direction to avoid heading errors. The simplest method for using these tie lines is to make each intersection agree by linearly distributing the error on each traverse line and holding the tie line values fixed-provided the tie line were acquired rapidly.

A local recording base station, i.e., diurnal station monitor, is the most ideal method and certainly the most accurate for removing time variations. The time variations can readily be removed from each reading, again assuming that the time is noted for each reading on the traverse to within a minute or so of the base station. The base station should not be further away than 100 miles from the area of the survey for agreement within a few gammas and should be positioned more than 200 feet away from local traffic and other disturbances (see Chapter VII). The diurnal base station, if left to continue recording during each evening, can indicate magnetic storms in progress and may be examined at the start of a survey day to determine if any useful measurements can actually be obtained during such conditions. During a magnetic storm, it is best not to obtain field data with the objective of removing the storm variations as the survey magnetometer and base station may not agree better than 5 or 10 gammas.

**High Magnetic Gradients**

In the case where an extremely high magnetic gradient destroys the signal as evidenced by successive non-repeating measurements, it may be necessary to raise the sensor up to 10 or 12, sometimes 15 feet in order to move the sensor to a region of lower gradient. This will only happen over outcropping or nearly outcropping large masses of perhaps altered ultrabasic rocks, magnetic iron ore deposits or ore bodies containing a large percent of pyrrhotite and in the near vicinity of buried iron objects in the applications for search. Such an event would only occur if the gradient exceeds several hundred gammas per foot. If the span of high gradient is not too wide, it may not actually be necessary to obtain measurements precisely at the highest gradient. Measurements on either side of the anomaly can be extrapolated or be used to at least indicate the contacts of such a highly magnetized formation. Furthermore, as the signal disappears and the readings diverge considerably from  $\pm 1$  or 2 counts, it may be worthwhile to note approximate indications of magnetic field gradient which on some instruments is displayed on the front panel as signal amplitude (which is a function of gradient). In areas of highly magnetic surface conditions, as noted in a previous section but where a signal is still obtained, another alternative in acquiring meaningful data other than that of using an extended staff would be to make 2 to 5 measurements per station, for example, at the points of a cross centered at the actual primary station location. The average of these readings would later be used to draw a profile. In this way, some of the surface noise is averaged out.

In the absence of anomalous surface conditions and for reasons more fully described in Chapter VIII, it may be useful for both geological and search applications to measure the vertical gradient of the total field. The vertical gradient is obtained by making 2 total field measurements, one over another, taking the difference in the readings and dividing by the distance between them.

**Data Reduction**

The profiles when plotted should be smoothly varying and expressive of the anomalies of interest. (NOTE: The nature of the disturbances or anomalies of interest, their width character, signature, and amplitude are discussed in Chapter V, following.) Should there be an excessive amount of such geologic/magnetic noise, at a

wavelength much shorter or much longer than is of interest, it is possible to apply simple filtering or smoothing techniques to facilitate interpretation of the profile. As a rule of thumb, *never remove or filter out anomalies whose wavelength is on the order of the depth to sources of interest.* A number of advanced techniques for data enhancement or filtering as employed in airborne surveys or well-gridded ground surveys will not be discussed within the scope of the Manual but are listed to acknowledge their existence: vertical derivatives, upward and downward continuation, reduction-to-the-pole, bandpass filtering, trend surface filtering, spectral analysis, trend enhancement, magnetization filtering, and others most of which are applied to two-dimensional data.

**Profile Smoothing**

Anomalies of very short wavelength (much shorter than the probable depths to sources of interest) may be present and caused by the magnetic effects of the magnetometer operator, or simply by surface magnetization contrasts in the surface or near-surface materials as mentioned earlier. In removing such effects, the eye itself tends to enhance what one is seeking. Another simple and obvious method is of course to pencil or trace through the noise. A more objective technique is to apply a running average or weighted running average to the data (see Figures 9 and 10). For a 3-point weighted

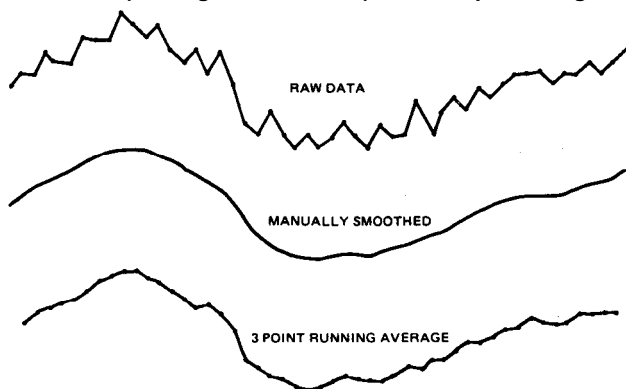

Figure 9. Profile Smoothing

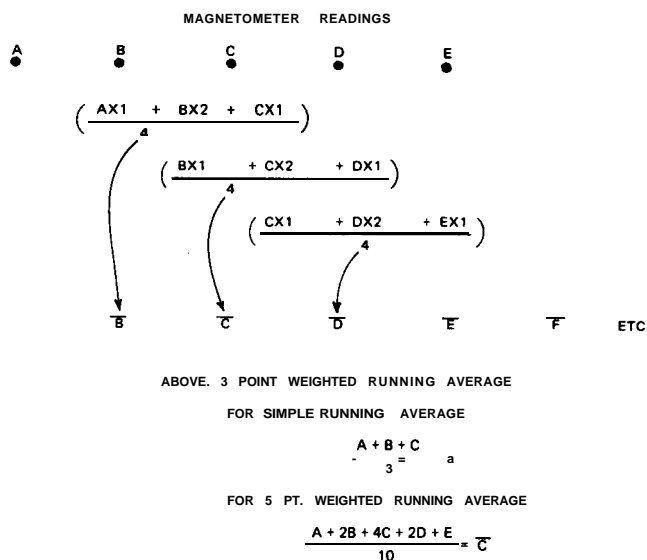

Figure 10. Running Averages

running average, for example, one would multiply the value at a given station by 2, add the values of the two adjacent stations, divide the sum by 4. This value is then set aside for that station for later recompilation of a new profile while advancing to the next station to perform the same procedure (see *figure 10*). A 5-point running average might utilize a weighting factor of 4 for the central point, 2 for each adjacent point, and 1 for the outside points while dividing by 10 to obtain the averaged value. More sophisticated techniques are also possible such as polynomial curve fitting, least squares, digital bandpass filtering, etc. The number of points or interval over which the averaging or filtering is to be performed for removal of such 'noise' should be much shorter (perhaps  $\frac{1}{5}$  to  $\frac{1}{10}$ ) than the anomalies of interest.

### Removal of Regional Gradients

In most cases, the anomalies of interest usually appear superimposed on a much broader anomaly which is not of interest. This broader anomaly, or regional gradient, due to the main earth's field or very deep or distant sources, may appear simply as a component of slope in the curve and although it is subjectively determined, is often removed from the data in order to better examine the anomaly. This gradient is removed from a single profile as shown by *Figure 11* by drawing a straight line or broadly-curved line through the non-anomalous portions of the curve. The values are then subtracted at each station and replotted to present the 'residual' values, hopefully expressing only the anomalies of interest which in this case would be the anomalies occurring at the shallower depths. The vertical gradient, measured according to the methods prescribed in Chapter VIII, also serves to remove or largely reduce the regional gradient.

### Contour Maps

Most survey traverses are not sufficiently close nor well-arranged in plan to allow the compilation of a contour map. Such is usually the case when only mineral explor-

ation data are desired, in broad reconnaissance surveys, or when surveying in extremely rugged terrain where large areas are otherwise inaccessible. Profiles are, in fact, usually adequate particularly for anomaly sources with very long, horizontal dimensions. Contour maps are nevertheless useful in cases where little is known of the geology or magnetic sources, where the anomaly sources are either small or extremely large, or for ascertaining, on a more objective basis, the distribution of the anomalous masses or very subtle longer wavelength features. Many surveys for search also require broad coverage and perhaps contour map presentation. An alternative to the construction of contour maps for broad two-dimensional coverage is the presentation of 'offset profiles' or profiles plotted on abscissae which also serve to show the location of the traverse lines drawn on a map.

Constructing a contour map requires that large effects from diurnal variations or the heading effects, if any, be removed; that is, that there be a single datum level for all traverses or readings. The process of removing the regional gradients, as described above, frequently serves to remove these other sources of errors as well and is satisfactory as long as one is not interested in the longer wavelength anomalies removed as part of the gradient.

The following guide should be useful to one not familiar with the techniques of constructing a magnetic contour map, or plan view of the anomalous total intensity. A contour or iso-intensity map is analogous to a topographic map and is a map on which are drawn lines (contours) of equal intensity, at convenient and regular intensity intervals, as would be observed were a magnetometer used to occupy every point on the surface of the ground. The contoured values are at best extrapolations and interpolations across areas where measurements are not actually taken. Such a map is drawn with the knowledge that the magnetic field is smoothly

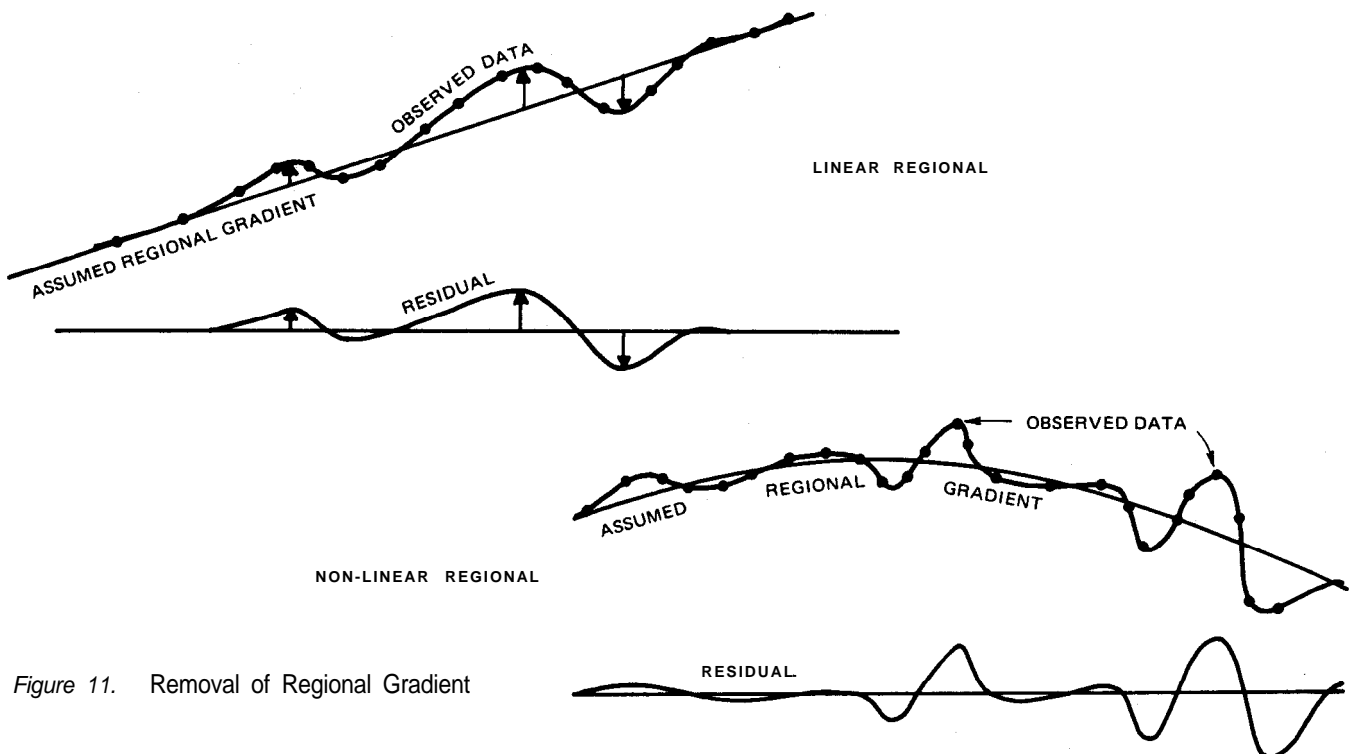

Figure 11. Removal of Regional Gradient



varying and on the assumption that one is interested only in broad features expressed by such a map. Features much smaller than the spacing between adjacent traverses should be examined on a profile basis only and should not be sought nor included on a map presentation.

### Construction of a Contour Map

Given a set of readings obtained on a traverse, the time variations, if significant, should be removed, perhaps the regional gradient removed and the profiles smoothed. Values are then selected from these smoothed profiles at widely-spaced intervals not less than, say,  $\frac{1}{2}$  or  $\frac{1}{4}$  the spacing between adjacent traverses or at **similarly spaced** but significant points on the profile, namely, maxima, minima, inflection points, etc. In other words, the values to be contoured should be more-or-less equally distributed in plan view. Anomalous features which 'obviously' extend across several traverses might be included also. The total intensity values thus selected and representative of the principal features are posted at their proper locations on a base map made of material which will support numerous erasing of penciled lines and including references to location.

Examine the dynamic range of the values and select 5 or 10 intensity levels through this range at convenient values such as every 20, 100, or 1000 gammas. Draw these contours according to the instructions below and then fill in the intermediate contour lines, i.e., every 10, 50, or 500 gamma contours, depending upon which coarse value above were originally selected, until con-

tours appear in all segments of the map. Magnetic intensity values and contours should, in theory, be smoothly varying and should thus be smoothed at the later stages of contouring by removing sharp bends or corners. After such smoothing, other contour lines as needed to cover the map adequately are carefully drawn between the fair-drawn contours and appropriate labels applied. In areas of steep gradients, only a few coarse contour lines are drawn to avoid numerous and insignificant fine details. Since closed contours (closures) appear the same for maxima and minima, they are differentiated by applying hashure marks or other indications on the inside of the minima.

The position of the various contours is selected by manually (eye and mental calculation or by using proportional dividers, although not really necessary) interpolating linearly between all the neighboring values as shown in *Figure 72*. In this case, it was decided to draw contours at 10 gamma intervals. The contour line near data point value 91 would subsequently be smoothed to pass through this data point following the guidelines given above.

Contour lines should never cross nor pass between pairs of data points which are both higher or both lower than the value of the contour. Also in some regions of zero or near zero gradient such as at a saddle point (region between two adjacent maxima or minima), there exists an ambiguity in the direction of the lines. However, it does not matter under such conditions which of the two possible sets of contours are drawn.

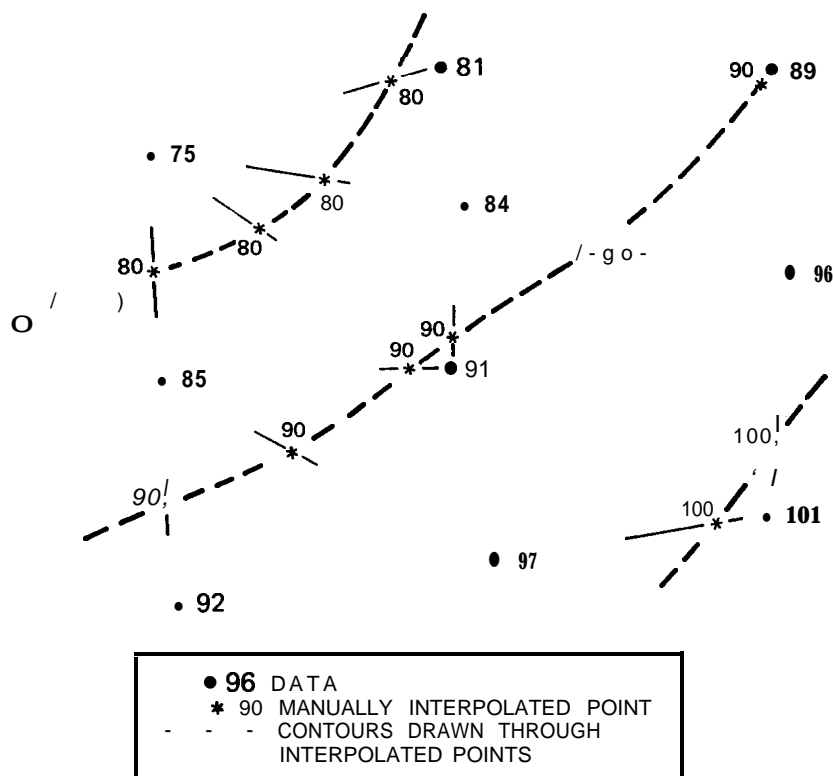

Figure 12. Interpolation and Contouring

# V. INTERPRETATION

## Introduction

Total magnetic intensity disturbances or anomalies are highly variable in shape and amplitude; they are almost always asymmetrical, sometimes appear complex even from simple sources, and usually portray the combined magnetic effects of several sources. Furthermore, there are an infinite number of possible sources which can produce a given anomaly. The apparent complexity of such anomalies is a consequence of the net effect of several independent but relatively simple functions of magnetic dipole behavior. With an understanding of these individually simple functions however, and given some reasonable assumptions regarding the geology, buried object or whatever other source one is seeking to understand, a qualitative but satisfactory interpretation can usually be obtained for most anomaly sources.

The interpretation, explanation and guide presented here is directed primarily towards a qualitative interpretation for both geological reasons as well as search applications, i.e., an understanding of what causes the anomaly, its approximate depth, configuration, perhaps magnetite content or mass, and other related factors. But even if qualitative information is derived from the data, it is important to have applied a reasonable amount of care in obtaining precise measurements. Quantitative interpretations are possible, but are applied more to airborne data, entail relatively complex methods for depth determination, and are the basis for a relatively large body of literature on the subject, references to which are given in the Manual.

An *anomaly* represents a local disturbance in the earth's magnetic field which arises from a local change in mag-

netization, or magnetization contrast as it is termed. A profile, for example over a very broad uniformly magnetic surface, although magnetic itself, will not exhibit a magnetic anomaly as there is no local change in magnetization. A local increase or even decrease on the other hand would constitute such a change and produce a locally positive or negative anomaly.

The observed anomaly expresses only the net effect of the induced and remanent magnetizations which usually have different directions and intensities of magnetization. Since the remanent magnetization is so variable and measurements of its properties seldom made, *anomalies are all interpreted* in practice as though *induced magnetization were the total source of the anomalous effects.*

## Asymmetry

The asymmetrical nature of total field anomalies is primarily a consequence of the directions of the field lines of the locally created magnet or source and the earth's-field-component nature of a total field magnetometer in the usually-inclined direction of the earth's magnetic field. Recall that a total field magnetometer measures only the component of any local perturbation which is in the direction of the earth's magnetic field at that point. Anomalies in the earth's field, whether **created** by induced or permanent magnetization, exist as arrangements of magnetic dipoles, monopoles (effectively), lines of dipoles and monopoles and sheet-like distributions of such poles. It is important therefore to understand the nature of the dipole or monopole field as it will be shown that a summation of such elementary forms will explain the most complex characteristics of anomalies and facilitate their interpretation. Notice, for example in *Figure 73*, the con-

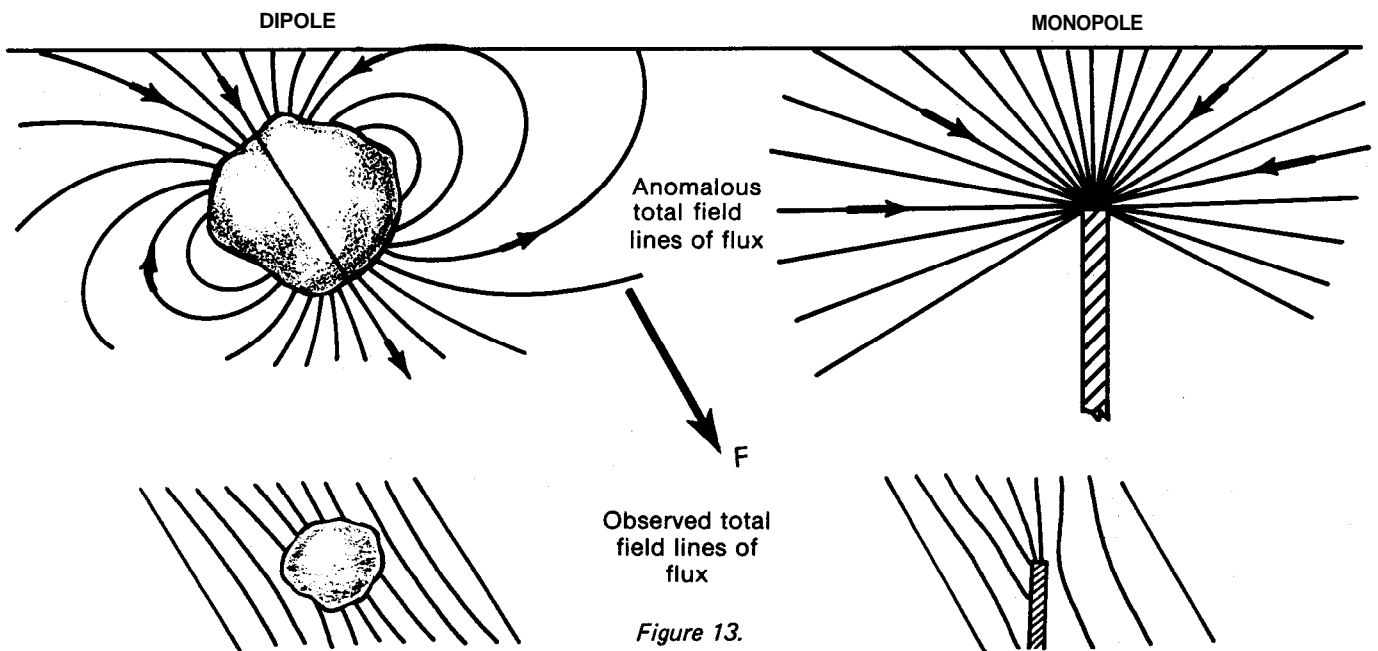

Figure 13.

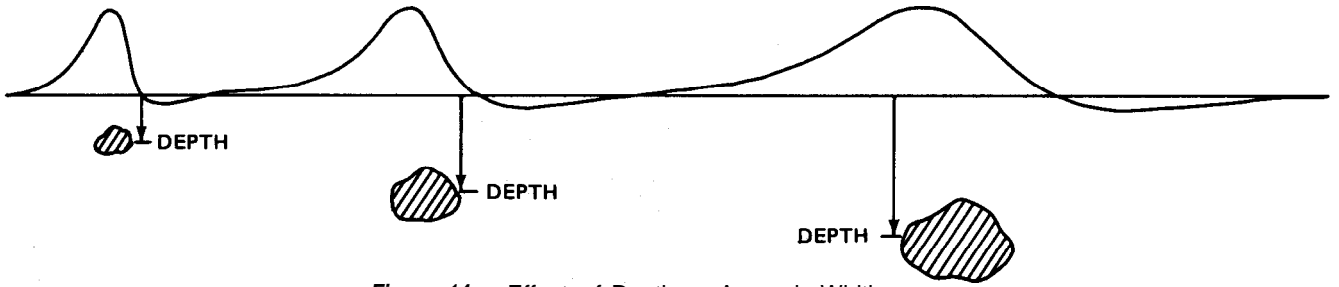

Figure 14. Effect of Depth on Anomaly Width

figuration for such fields as they would appear if one were to measure the direction of the anomalous field.

**Depth Dependence**

Another significant characteristic of a magnetic anomaly is its variation with the depth between the magnetometer and source, the deeper the source, the broader the anomaly as expressed in Figure 74. It is this property which enables one to determine the approximate depth to the source independent of any other information concerning the source. *If one familiarizes himself with only one subject in this discussion on interpretation, it should be the general characteristics of anomaly wavelength, or width, as a function of depth.* A knowledge of this subject allows rapid and easy interpretation of anomalies of interest when numerous anomalies arising from various depths appear in the observed total intensity profile.

**Other Anomaly Shape Factors**

Other factors which affect the anomaly shape and amplitude are the relative amounts of permanent and induced magnetization, the direction of the former, and the amount of magnetite present in the source compared to the adjacent rocks. The actual configuration of the source, that is, whether it is narrow, broad or long in one dimension and its direction in the earth's field, also control the anomaly signature.

**Geological Models**

Geological anomalies are interpreted in terms of much simplified geological models which very much facilitate interpretation procedures. The first simplification is the assumption that magnetization is uniform within some elementary prismatic form and that the magnetization is different outside this form, i.e., there is a magnetization contrast. Typical of the kinds of geologic sources that are assumed to cause anomalies are those which are shown in Figure 15.

As was stated, in any potential field method the given magnetic signature can be produced by an infinite combination of sources so that there is no unique interpretation. For example, the same anomaly could be produced by the peculiar distribution of magnetite (unrealistic geologically), and a uniform distribution of magnetite within the prismatic form (realistic), both of which are shown in Figure 76. It must be emphasized that not only are simplifications required, but a reasonable geologic framework must be used as a guide when considering the various possible sources. A typical set of anomaly signatures of various sources might appear as in Figure 77.

**Elementary Dipoles and Monopoles**

Since anomalies are explained herein in term of various arrays of dipoles and monopoles, it is important to examine their geometry and intensity characteristics. A magnetic dipole produces a field with imaginary lines of flux as shown in Figure 78. The intensity of the field, which is proportional to the density of the flux lines is drawn as lines of equal intensity to express this relationship. From Figure 78, notice that 1) the intensity of the dipole is twice as large off the ends of the dipole as it is at the same distance off the side of the dipole. This explains, for example, why the earth's magnetic field is approximately 30,000 gammas at the magnetic equator and 60,000 gammas at its poles; 2) the direction of the field off the side of the dipole is parallel to the dipole itself, but opposite in sense; 3) the direction of the tangent of the field lines of a dipole are parallel along any radial line from the dipole.

A monopole has field lines which point radially in or out from the positive or negative monopole respectively. The intensity is constant at a given distance and any direction from a monopole. In actual fact, there are no magnetic monopoles, but only dipoles whose ends are far apart. For all practical purposes, however, monopoles exist in terms of the distance to the source and such geological configuration as shown in Figure 73.

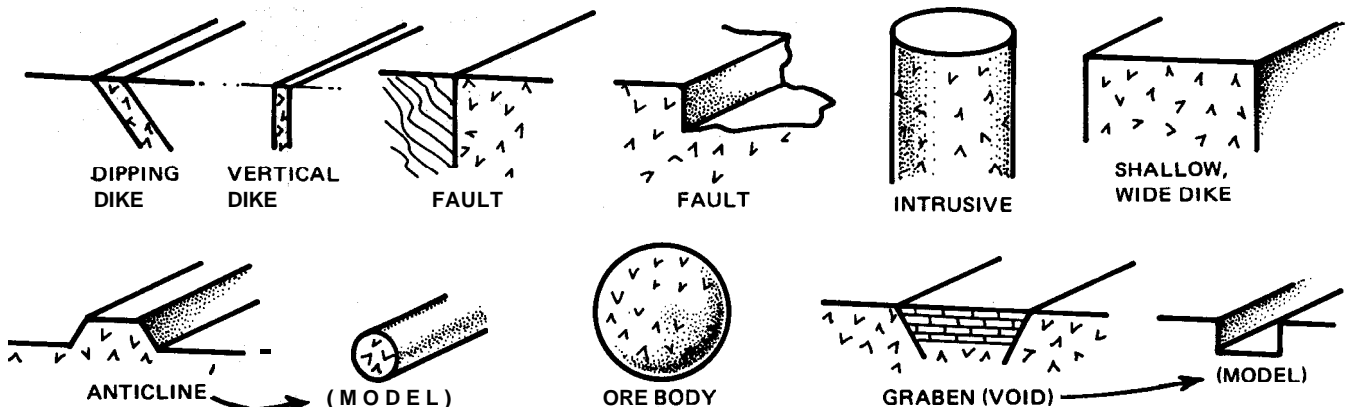

15. Geological Model Representations of Common Magnetic Anomaly Sources

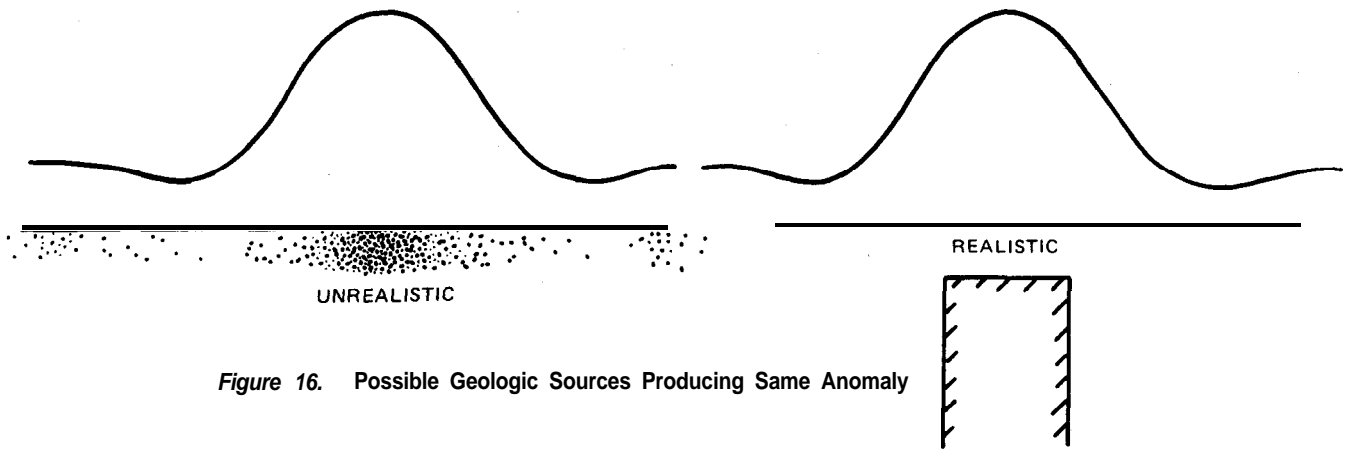
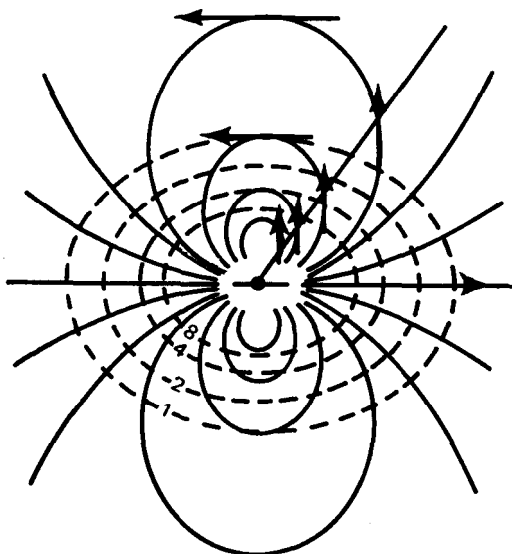

Figure 16. Possible Geologic Sources Producing Same Anomaly



LINES OF FLUX (—) AND LINES OF EQUAL INTENSITY (---) FOR A DIPOLE

Figure 18.

Having outlined the qualitative geometry of the intensity  $T$  from a dipole, the quantitative aspects can be considered as follows:

The intensity,  $T$ , from a dipole can be expressed as

$$T = \frac{2M}{r^3} \text{ along the axis, i.e., off the end of the dipole,}$$

$$\text{and } T = \frac{M}{r^3} \text{ along a line at right angles to the dipole, i.e., off the side of the dipole,}$$

and for a monopole

$$T = \frac{M}{r^2} \text{ in any direction from a monopole, where}$$

$M$  = magnetic moment and  $r$  is the distance to the pole. A more detailed mathematical formulation for the intensity due to a dipole is given subsequently in this Chapter.

#### Simplified Method for Total Field Signature

From the above description of a dipole and monopole and with the knowledge of the earth's-field-component-nature of the total field magnetometer, it is possible to sketch the signature of an anomaly for any given orientation of the dipole (orientation caused by field direction, the direction of remanent magnetization, or by the configuration of the geology). It is helpful to draw such signatures at various inclinations of the magnetic field to understand where the *sources* would be located with respect to the signature, the dip of the magnetization producing the anomaly, and even for information related to the depth of the source. Remember that all anomalies can be considered as caused by various distributions of dipolar and monopolar sources and it is possible to produce any anomaly simply by the super-position of such dipole or monopole signatures derived here.

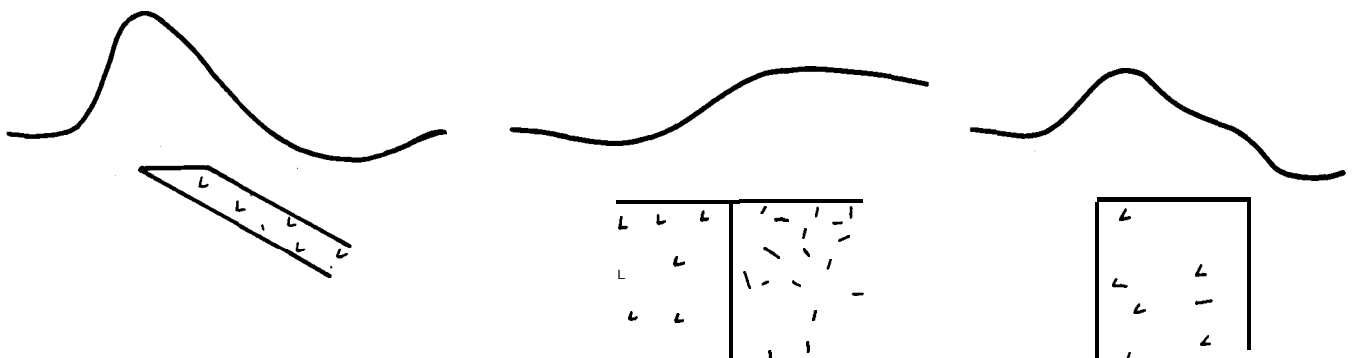

Figure 17. Typical Anomalies for Simple Geologic Models

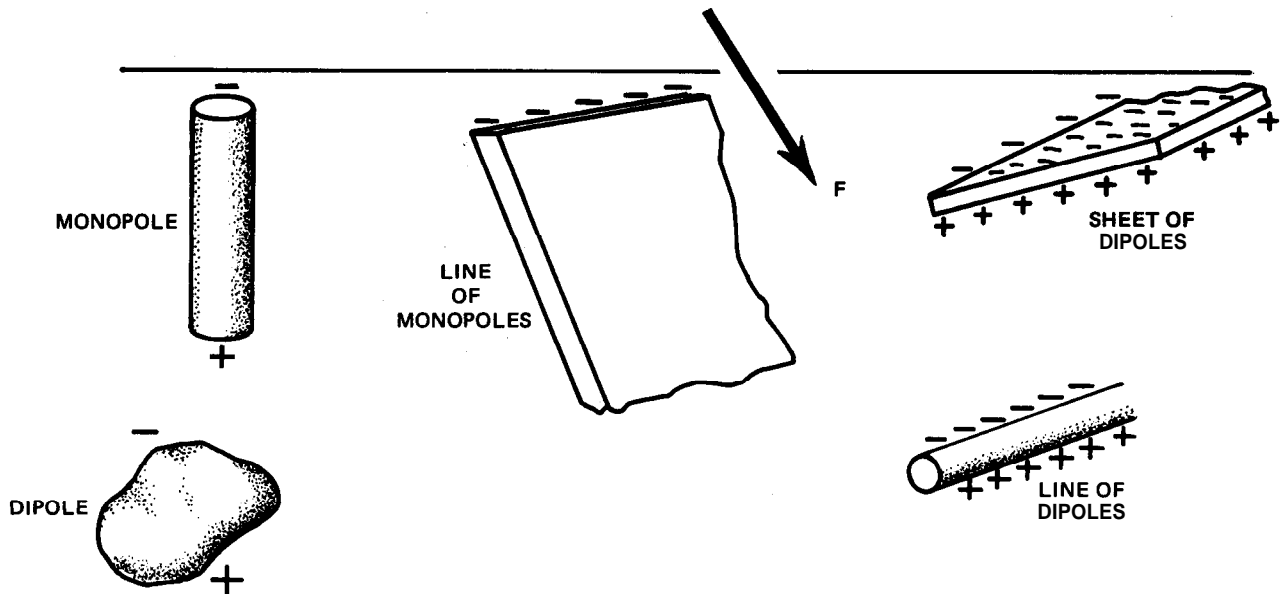

Figure 19.

### Earth's Field Component Behavior

This method of predicting or drawing the anomaly signature depends upon one property of the field, namely, inclination, and three properties peculiar to the dipole or monopole source, whichever is assumed. The dip of the earth's field is first considered because this is the direction, the only direction, of the components of any local magnetic anomalies which are measured by a total field magnetometer. (If one is using a vertical component magnetometer, this guide still applies except that instead of using the earth's field as the direction of measurement, simply use the vertical.) In other words, the magnetometer will only measure the component of a local perturbation in this direction, i.e., as projected into this direction. See *Figure 20*.

### Dipoles vs. Monopoles vs. Arrays of Poles

The decision to use dipoles, monopoles, or other configurations as the model is based upon the manner in which the earth's field induces a local field and this in turn depends upon the configuration of the geologic body which exhibits the magnetization contrast and the direction of the field. For example, a long body which nearly parallels the earth's field will tend to be magnetized along its long dimension. Furthermore, if the body is sufficiently long with one end near the magnetometer, the anomaly will appear as a monopole seeing only the upper pole with the lower pole removed effectively to infinity. If the same long, thin body were normal to the field, it would then be magnetized through its thinnest dimension producing the sheet-like array of dipoles as shown in *Figure 19*.

One may wish to draw on the typical models depicted in *Figure 15*, the array of poles from a uniform earth's field at various inclinations and orientations of the source. Whether the monopoles or the dipoles (and its equivalent line or sheet distributions) are close or far apart, determines if the model is to be considered a dipole or monopole, respectively (see, for example, *Figure 34*).

### Configuration of Field Lines

The first property of the dipole or monopole which is to be considered is the configuration of the field lines (see

*Figure 13*). When superimposed upon the component which is measured by the total field magnetometer, it can be seen that the relative lengths of the disturbance vectors that are measured are those shown in *Figure 21* for an induced dipole and monopole source. It is the relative length of these disturbance vectors drawn along the total field direction that is measured, each disturbance vector, in turn, weighted by the intensity functions described below.

### Dipole and Monopole Fall-Off Factor

The next factor to be considered is the variation of intensity with distance, i.e.,  $1/r^3$  and  $1/r^2$  factors for the dipole or monopole fields respectively and as expressed in the preceding equations. The relative intensity for dipoles or monopoles as a function of distance to their centers as would be observed along a traverse is presented in *Figure 22* and described mathematically under "Anomaly Amplitude" below. This factor multiplies the length of net vectors in *Figure 21*.

### Dipole Factor-of-Two

The last consideration really only applies to the dipole and that is a factor of 2 when one is off the end of the dipole compared to a position off the side. In other words, at a given distance, the intensity varies by a factor of 2 as a function of the angle between the radial line to the dipole and the dipole axis. This function is shown approximately in *Figure 23* for the dipole used in the example. The monopole possesses radial symmetry and therefore requires no such consideration.

### Application of Method

A dipole and monopole signature is thus constructed in *Figure 24*. The amplitude is dimensionless, but can be compared to a real anomaly by multiplying by a single factor derived below from considerations of volume, susceptibility, etc. However, applying these factors even qualitatively should allow one to draw the dipole and monopole signatures for variously inclined fields and geometries. *Figure 25*, for example, is drawn free-hand for anomalies in vertical field ( $90^\circ$  inclination), magnetic equator and mid-southern latitudes. By simply sketching in the earth's field direction and the dipole's field lines

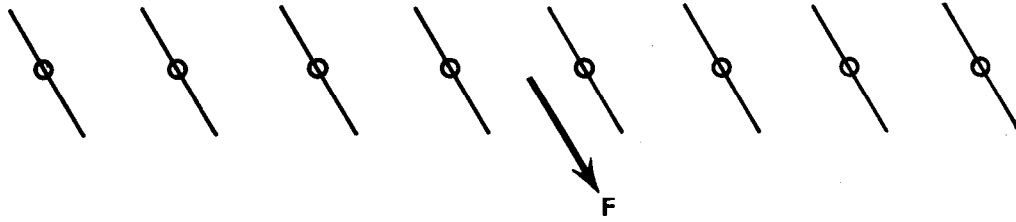

Figure 20. Direction of Components Measured by Total Field Magnetometer

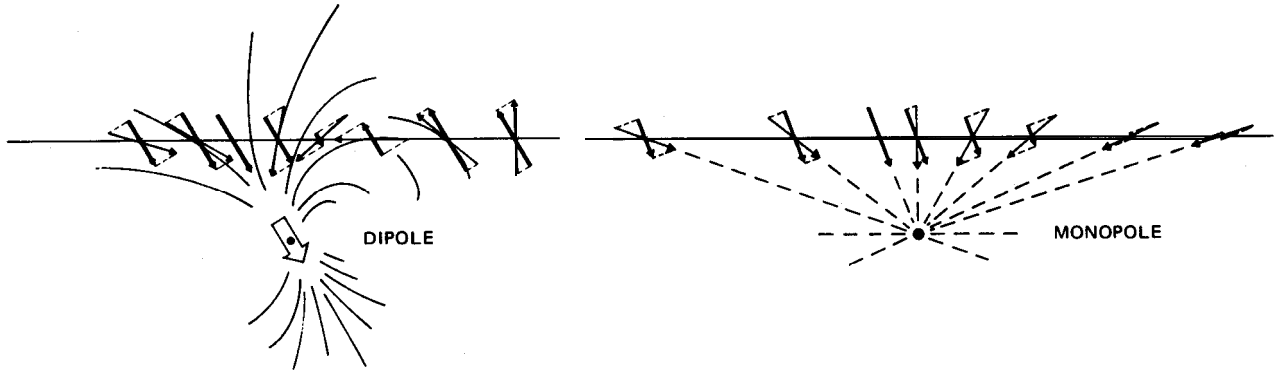

Figure 27. Total Field Components of Tangent to Field Lines of Dipole and Monopole

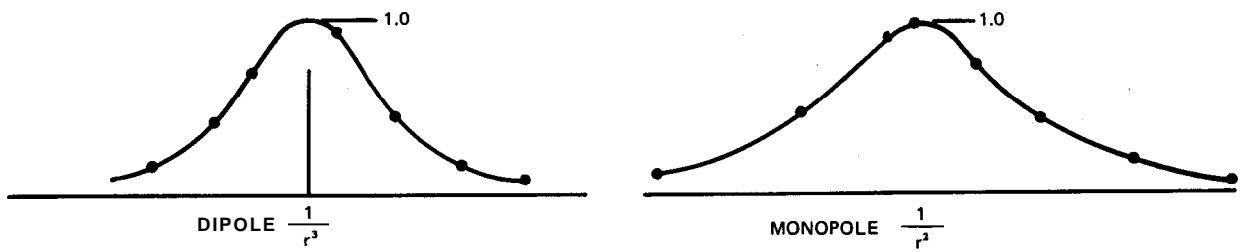

Figure 22. Fall-off Rate  
(Relative intensity or length of vectors in Figure 21)



Figure 23. Aspect Factor  
(Relative Intensity of Dipole of Figure 21 with Respect to Angle from Axis at Various Points Along Profile)

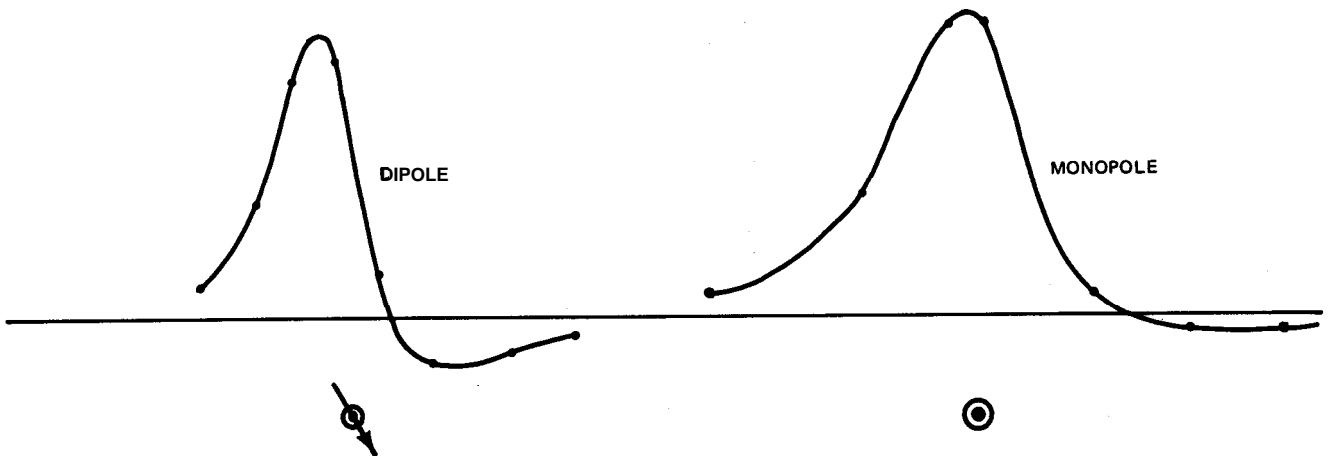

Figure 24. Dipole and Monopole Signatures (Constructed from Figures 20-23 according to methods described in text.)

without consideration of the other last two factors, it is possible to appreciate the basis for:

a negative anomaly over sources at the magnetic equator,

absence of anomalies in the central portion of elongate N-S anomalies at the equator,

both positive and negative fields for almost any anomaly,

changes in anomaly character for different directions of the dipole,

asymmetry of anomalies,

monopole which has only positive sense yet for most inclinations still produces a total intensity anomaly with both positive and negative portions.

The simple exercise of drawing such anomalies may also elucidate other characteristics of signatures, which to many not familiar with magnetics or such behavior as shown here, appear to be complex and difficult to comprehend.

Based upon the above procedures, applied qualitatively, and upon the manner in which lines of flux are induced in various configurations of geologic bodies and ambient field directions and inclinations, it is possible to derive the various signatures shown in *Figure 26* (drawn free-hand). By varying the effect of depth as it produces an anomaly of longer wavelength, and by building composite anomalies such as summing the effect of 2 faults to create a single wide, shallow dike, it is also possible to generate a composite curve demonstrating the effect of different sources and different depths which is the typical observation.

**Contour Presentation of Dipole and Prism Anomalies**

**Profiles of total intensity are usually** the only form of presentation from ground measurements even when data are taken on a 2-dimensional array. If measurements are taken properly, however, it is possible to construct a contour map by the methods described in Chapter IV. It is therefore useful to examine a few special cases of contour maps that would be expected oversimple sources such as a dipole and a wide, vertical prism in various latitudes. Such a contour map also allows one to extract, even by simple inspection, how a given profile would appear at various positions over such simple-shaped forms which is useful information both in search and in

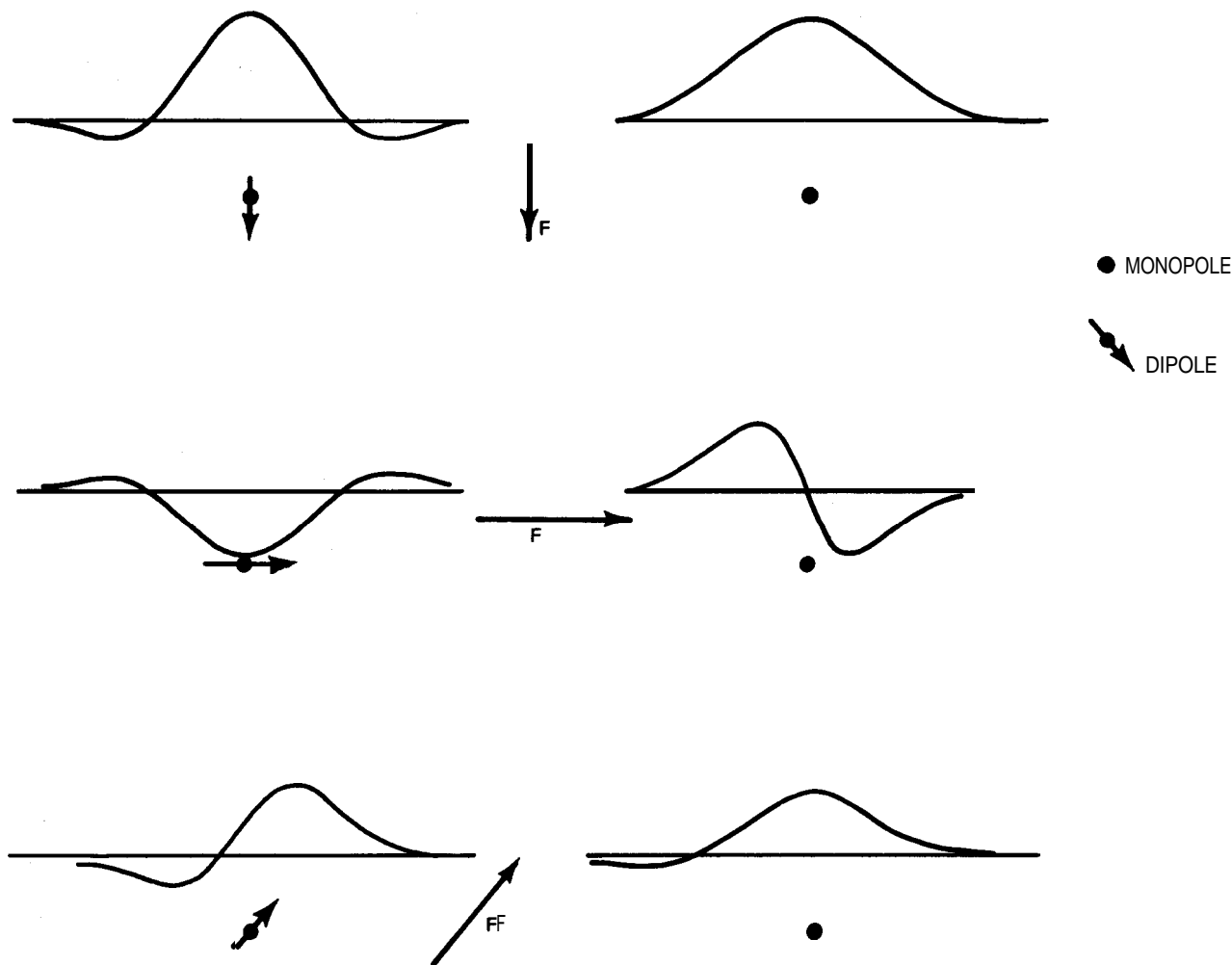
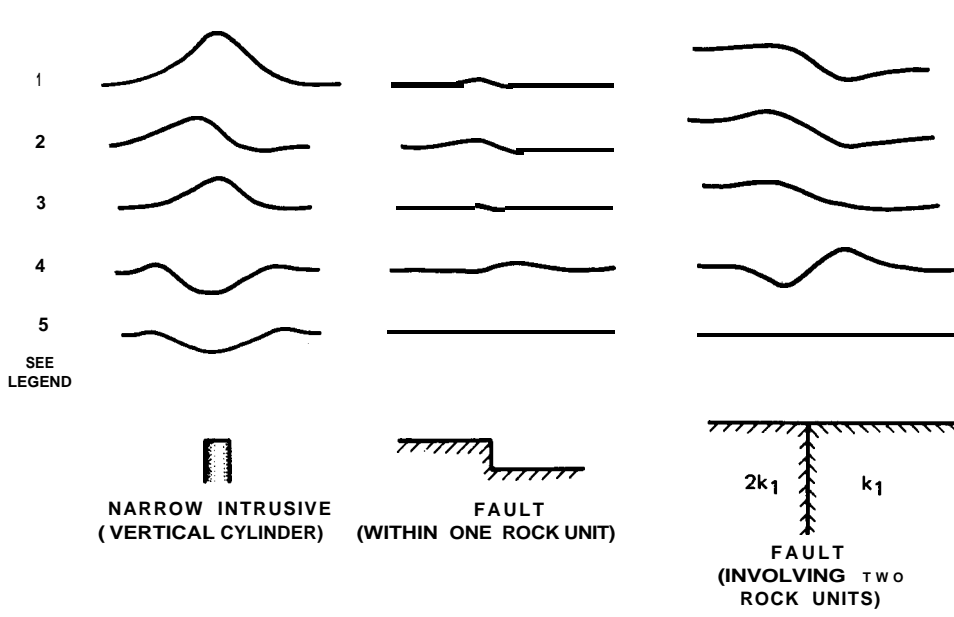
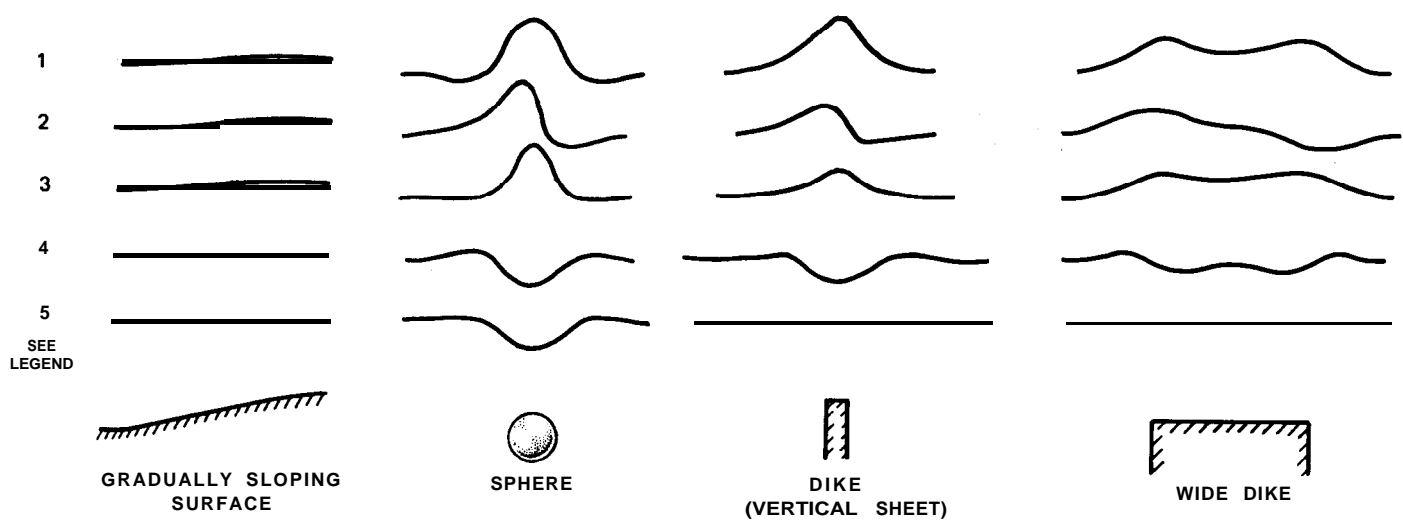
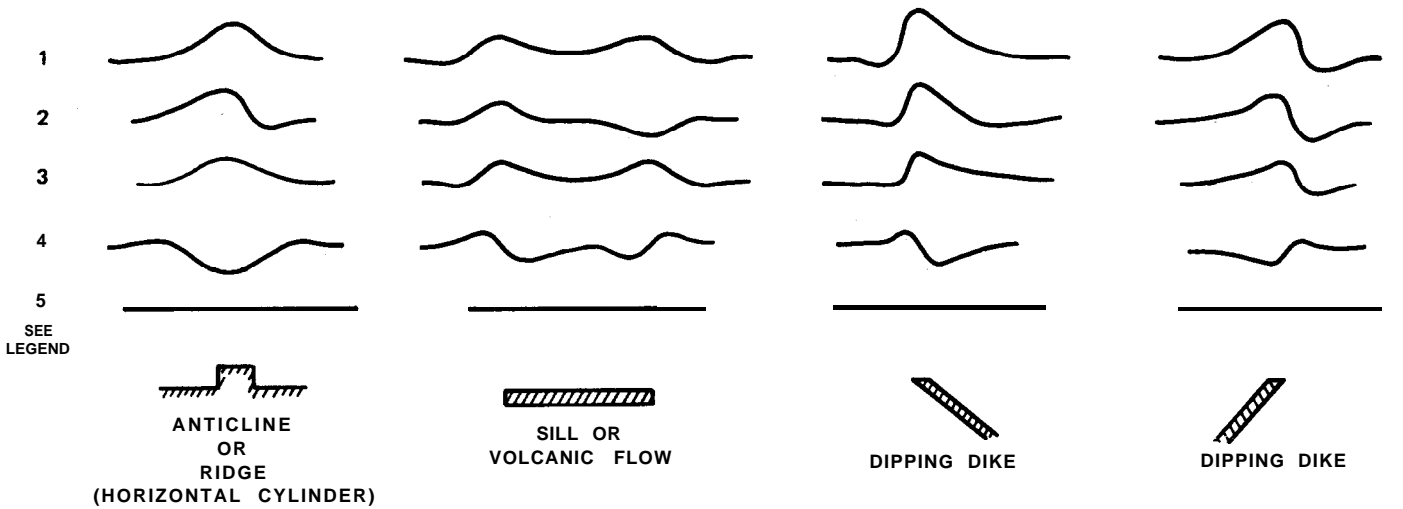

Figure 25. Free Hand Sketch of Dipole and Monopole for Various Inclinations



TYPICAL ANOMALIES FROM VARIOUS GEOLOGIC BODIES (SHOWN FREE HAND - DO NOT USE AS QUANTITATIVE REFERENCE)

ALL ANOMALY SOURCES EXCEPT SPHERE AND VERTICAL CYLINDER ARE INFINITELY LONG NORMAL TO THE PLANE OF THIS PAGE.

LEGEND

- 1)  $\downarrow F$
- 2)  $\swarrow F$  OR  $\searrow F$  TRAVERSE N-S  
(N $\rightarrow$ ) (N $\rightarrow$ )
- 3)  $\swarrow F$  OR  $\searrow F$  TRAVERSE E-W  
(i.e., PROJECTION OF FIELD INTO PLANE OF THIS PAGE IS VERTICAL)
- 4) -F TRAVERSE N-S  
(N $\rightarrow$ )
- 5) -F TRAVERSE E-W  
(i.e., FIELD IS NORMAL TO PLANE OF THIS PAGE)



geological exploration. Contour maps and selected profiles drawn across the anomaly are sketched in Figure 27.

### Anomaly Amplitude

#### Amplitude Estimates for Common Sources

The large amplitude commonly observed anomalies (several hundred gammas or larger) are almost always the result of a large magnetization contrast, i.e., change in lithology where one igneous rock is in juxtaposition with another or with a sedimentary or metamorphic rock of much lower susceptibility. It must be remembered that magnetization of common rocks varies over 6 orders of magnitude. Anomalies due to structure alone, i.e., varying configuration of a uniformly magnetized rock, seldom produces anomalies larger than 10 or 100 gammas.

The relative amplitude of a given anomaly (signature) has been shown to be a function of the earth's field direction, the configuration of the source and the remanent magnetization if any. The *maximum* amplitude of an anomaly is, on the other hand, largely a function of the depth and the contrast in the mass of magnetite (or iron, etc. in the case of search), and to a lesser extent, the configuration of the source. It is of interest to be able to estimate the maximum amplitude for a given source in order to 'model' it for the sake of interpretation. This estimated amplitude can be used with the normalized, i.e., dimensionless, anomaly signatures above and in Figure 26 to produce the anomaly one wishes for comparison with the observed. Estimation of the maximum anomaly amplitude is also useful in planning a survey or planning the grid and coverage necessary in search applications.

For a few generalized configurations, it is relatively simple to estimate the maximum anomaly amplitude (at a single point above the source) assuming a depth, susceptibility and much simplified shape of the source. Expressions are given in the literature for calculation of anomalies of more complex figures and later in this section the calculation of the complete signature, i.e., the amplitude as a function of distance along the profile for a few simple forms. The methods described herein are merely order-of-magnitude techniques, but are useful for the applications covered by the Manual.

Estimation of the maximum anomaly for comparison with a given source requires first that the signature be studied for the nature of the source; namely, whether the source can be approximated as an isolated dipole, monopole, or line or sheet-like array of such. In the case of the latter two, adjacent traverses or a contour map may be required to determine if it is 2-dimensional, i.e., very long normal to the traverse. A depth is then assumed or crudely estimated (according to procedures that follow). In addition, the susceptibility is assumed or if source rocks are accessible, it is measured following methods outlined in Chapter VI. The formulae below can then be used remembering that they are based upon simplifications and assumptions and are often no better than a factor of two.

The basic expression for estimating the maximum amplitude of any anomaly is

$$T = \frac{M}{r^n}$$

where T is the anomaly, M the magnetic moment, r the distance (depth) to the source, and n a measure of the

rate of decay with distance, or fall-off rate (n = 3 for a dipole, n = 2 or a monopole, etc.).

Since the magnetic moment M (and k) is usually given in centimeter-gram-second (cgs) units, r must be in centimeters, n is dimensionless and T is in gauss. To express T in gammas, multiply M by  $10^5$ ; if r is in feet, multiply r by 30 and raise the quantity 30r to the exponent n, e.g., if the source is a dipole, then n = 3, and if say, r = 2 feet, M = 1000 cgs,

$$\text{then } T = \frac{1000 \times 10^5}{(2 \times 30)^3} = 460 \text{ gammas.}$$

### Dipole and Monopole Signatures in Vertical and Horizontal Fields

The very generalized expression for the maximum anomaly one may expect from a dipole or monopole was presented above in its very simplest form. It may be of interest, however, to construct the signature of a dipole or monopole in a vertical or horizontal earth's field as would be observed by a total field magnetometer along a traverse over the source.

Apart from any total field considerations, a dipole has a field with magnitude and direction given by the radial and tangential components,  $T_r$  and  $T_\theta$ , according to the following expression and for the geometry shown.

$$T_r = \frac{2M \cos \theta}{r^3}$$

$$T_\theta = -\frac{M \sin \theta}{r^3}$$

Where the earth's field is vertical or nearly vertical (dip  $70^\circ$  to  $90^\circ$ ), the dipole, if induced, would also be vertical and the total field magnetometer would measure the component,  $T_z$ , along this vertical direction, where

$$\begin{aligned} T_z &= T_r \cos \theta + T_\theta \sin \theta \\ &= \frac{2M \cos^2 \theta - M \sin^2 \theta}{r^3} \\ &= \frac{M(2z^2 - x^2)}{(x^2 + z^2)^{5/2}} \end{aligned}$$

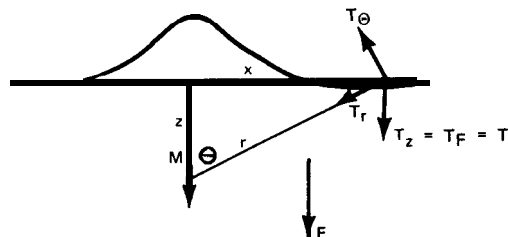

As before,  $T_z = T_F = T$ , the anomaly.

$$\text{At } x = 0, \quad T = \frac{2M}{z^3}$$

$$\text{at } x = \pm z, \quad T = \frac{0.175M}{z^3}$$

$$\text{at } x = \pm \sqrt{2}z, \quad T = 0$$

$$\text{at } x = \pm 2z \quad T = \frac{-0.04M}{z^3}$$

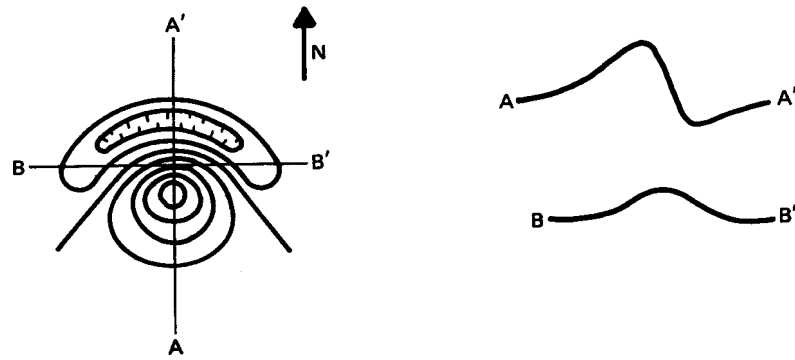

DIPOLE, INCLINATION OF F,  $60^\circ$   
 (FOR INCLINATION  $-60^\circ$ , I.E., SOUTHERN HEMISPHERE, N IS  $\downarrow$ )

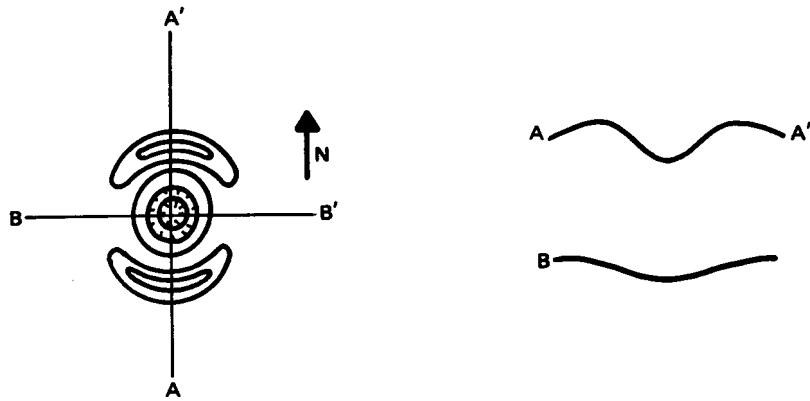

DIPOLE, HORIZONTAL FIELD

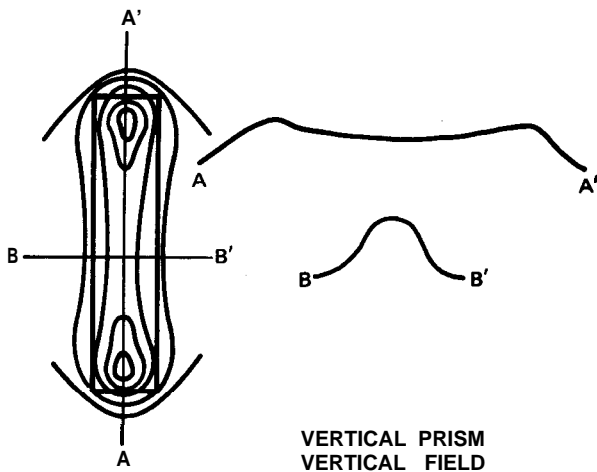

VERTICAL PRISM  
 VERTICAL FIELD

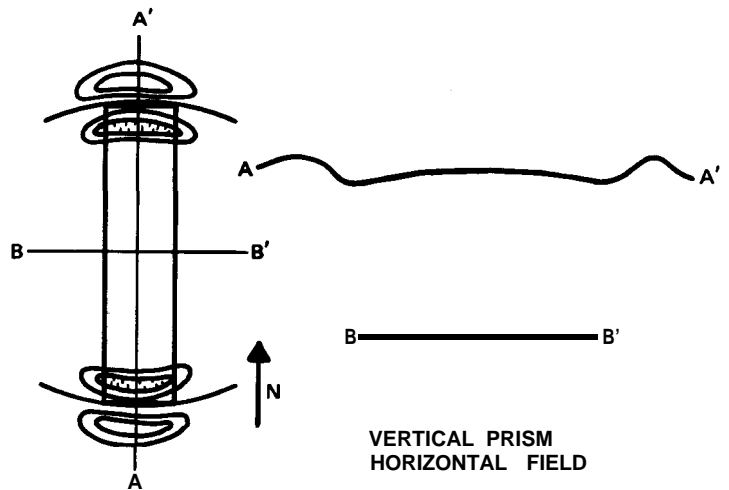

VERTICAL PRISM  
 HORIZONTAL FIELD

Figure 27. Contour Maps of Total

For magnetic equatorial fields, the induced anomaly is horizontal and the total field magnetometer would measure the components shown and expressed by

$$T_x = T_r \cos \theta + T_e \sin \theta$$

$$= \frac{2 M \cos^2 \theta - M \sin^2 \theta}{r^3}$$

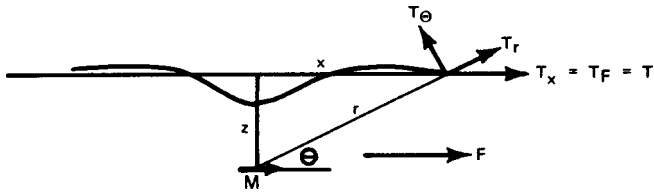

$$= \frac{M (2x^2 - z^2)}{(x^2 + z^2)^{5/2}}$$

as before,  $T_x = T_F = T$  the total field anomaly, where,

at  $x = 0$ ,

$$T = -\frac{M}{z^3}$$

at  $x = \pm \frac{z}{\sqrt{2}}$ ,

$$T = 0$$

at  $x = \pm z$ ,

$$T = \frac{0.175 M}{z^3}$$

at  $x = \pm 2z$ ,

$$T = \frac{0.125 M}{z^3}$$

The monopole shown here has only radial components whose intensity is expressed by

$$T_r = \frac{M}{r^2}$$

The monopole anomaly in a vertical field as measured by a total field magnetometer would be the component in the z direction (vertical) or

$$T_z = T_r \cos \theta$$

$$= \frac{M \cos \theta}{r^2}$$

$$= \frac{Mz}{(x^2 + z^2)^{3/2}}$$

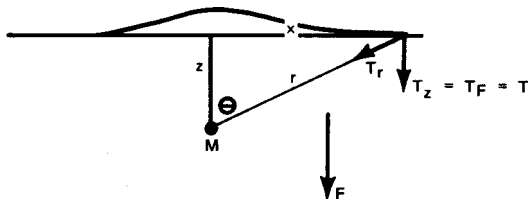

assigning  $T_z = T$ , the anomaly

at  $x = 0$ ,

$$T = \frac{M}{z^2}$$

at  $x = \pm z$ ,

$$T = \frac{0.35 M}{z^2}$$

at  $x = \pm 2z$ ,

$$T = \frac{0.09 M}{z^2}$$

The monopole field in a horizontal field would be measured by a total field magnetometer as the horizontal component,  $T_x$  where

$$T_x = T_r \sin \theta$$

$$= \frac{M}{r^2} \sin \theta$$

$$= \frac{Mx}{(x^2 + z^2)^{3/2}}$$

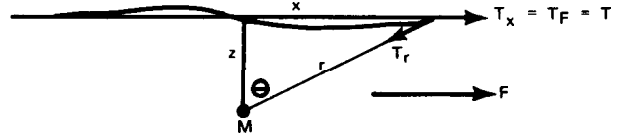

Again,  $T_x = T_F = T$ , the anomaly, where

at  $x = 0$ ,

$$T = 0$$

at  $x = z$ ,

$$T = -\frac{0.35 M}{z^2}$$

at  $x = -z$ ,

$$T = \frac{0.35 M}{z^2}$$

at  $x = 2z$ ,

$$T = -\frac{0.18 M}{z^2}$$

at  $x = -2z$ ,

$$T = \frac{0.18 M}{z^2}$$

**Maximum Amplitude Given Magnetization and Generalized Form**

The magnetic moment M is more usefully expressed as

$$M = IV$$

where I is the magnetization (i.e., magnetization contrast) per unit volume and V the volume. This magnetization is composed of a usually unknown proportion of remanent magnetization,  $I_r$ , and induced magnetization  $I_i$ . The latter as expressed in Chapter III is

$$I_i = kF$$

where k is the magnetic susceptibility per unit volume and F the earth's field or ambient inducing field. (NOTE: Since  $I_r$  is seldom known, an effective magnetization,  $I = I_i + I_r$ , will always be used. Also it is assumed that  $k < 10^{-2}$ , i.e., the source under consideration contains less than 10% magnetite; then one can ignore what is known as demagnetization effects in the calculation of anomaly amplitude).

Therefore, for a dipole which can always be assumed for a source all of whose dimensions are small with respect to the distance (less than  $1/5$  or  $1/10$ ) to the magnetometer,

$$T = \frac{M}{r^3} = \frac{IV}{r^3} = \frac{kFV}{r^3}$$

If the source is approximately spherical, then

$$T = \frac{kF \left(\frac{4}{3} \pi R^3\right)}{r^3}$$

where R is the radius of the source as in figure 28

If the measurement is made along the axis of the dipole (see Figure 29), then

$$T = \frac{2kF \left(\frac{4}{3} \pi R^3\right)}{r^3}$$

$$T = \frac{kF \left(\frac{4}{3} \pi R^3\right)}{r^3}$$

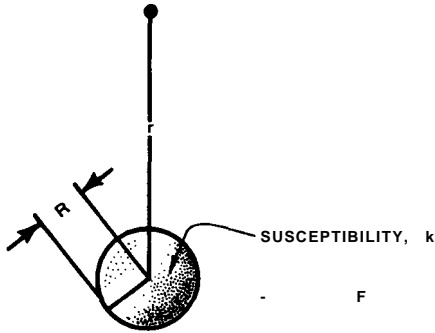

Figure 28. Anomaly of Sphere in Horizontal Field

$$T = \frac{2kF \left(\frac{4}{3} \pi R^3\right)}{r^3}$$

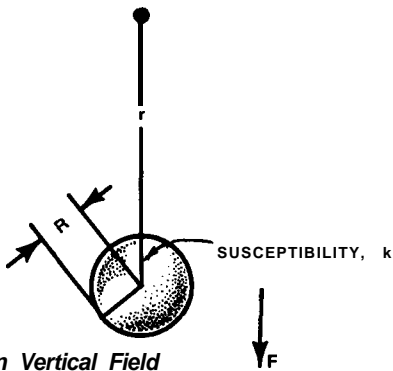
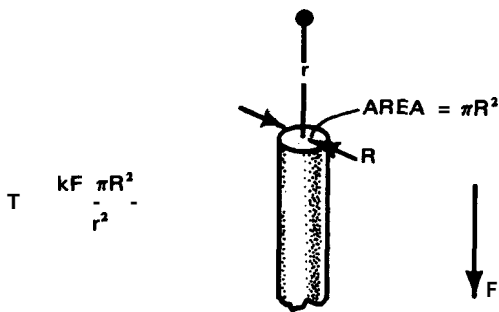

Figure 29. Anomaly of Sphere in Vertical Field

As an example, consider an ore body 100 feet wide (R = 50), 500 feet deep comprised of 10% magnetite (k = 0.3), in a steeply dipping field (60° to 90° latitude) in a field of 60,000 gammas:

$$T = 2 (0.10 \times 0.3) \times 6 \times 10^4 \left(\frac{4\pi}{3}\right) \left(\frac{50}{500}\right)^3 = 14.4 \text{ gammas}$$



(NOTE: ALSO VALID FOR END OF N-S HORIZONTAL CYLINDER IN HORIZONTAL FIELD)

For the same ore body in an equatorial field where F = 30,000 gammas and the induced dipole is now observed at a point on a line normal to the axis (no factor of 2)

$$T = -3.6 \text{ gammas}$$

Thus a given dipolar source in an equatorial field will have only 1/4 the maximum anomaly amplitude it would have in a polar region.

The above expressions are usually valid only for such sources as a small distant ore body (containing magnetite), small structure in deep basement, or most objects involved in search applications (see Chapter VII). The magnetization is expressed in gauss or gammas as desired. Since the anomalies are also expressed in terms of magnetic units, it follows that the units of dimension in the numerator must be of the same order as the denominator since they must cancel. Therefore, for a dipole whose anomaly varies as  $\frac{1}{r^3}$  (said to have a fall-off of  $\frac{1}{r^3}$ ), the volume, V, has dimensions of  $R^3$ . In the case of a monopole, which varies as  $\frac{1}{r^2}$ , the magnetic moment, M, is equal to IA where A is surface area and has dimensions of  $R^2$ . Consider for example, a vertical basement intrusive in a polar region with an upper surface 1000 feet in diameter at a depth of 5000 feet, with a susceptibility contrast of  $10^{-2}$  in a field of 60,000 gammas. Thus,

$$T = \frac{kF \pi R^2}{r^2} = 10^{-2} \times 6 \times 10^4 \times \pi \left(\frac{500}{5000}\right)^2 = 18 \text{ gammas.}$$

Horizontal prisms or cylinders also vary as  $\frac{1}{r^2}$ , with magnetic moment M equal to 2IA (IA for E-W horizontal prisms in equatorial regions) where A is the cross-sectional area of the prism (see figure 30). (NOTE: The long horizontal prism varies as  $\frac{1}{R^2}$  not because it appears to be comprised of a monopole, but because it is a line of dipoles (in steeply dipping fields) and the effect of adjacent dipoles along an infinitely long line is 'seen' more by the magnetometer at a distant point of measurement than if all the magnetization were concentrated at a point as in an isolated dipole).

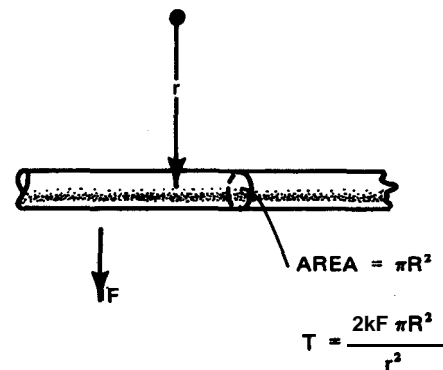

(NOTE: ALSO VALID FOR E-W HORIZONTAL CYLINDER IN HORIZONTAL FIELD)

Figure Anomaly of Vertical and Horizontal Cylinders

A narrow, vertical dike in steep field or the edge of a horizontal sheet in a horizontal field can be considered as a line of monopoles varying as  $1/r$  which is a lower rate of fall-off than a single monopole for the same reasons given above for a horizontal cylinder (see Figure 37). The magnetic moment  $M = It$  where  $t =$  width of dike. Since the anomaly varies as  $1/r$ , the dimensions of  $t$  are simply length. As an example, a vertical dike might be 100 feet wide, at a depth of 500 feet, with  $k = 10^{-3}$  in a field of 50,000 gammas, or

$$T = \frac{kFt}{r} = \frac{10^{-3} \times 5 \times 10^4 \times 10^2}{5 \times 10^2} = 10 \text{ gammas}$$

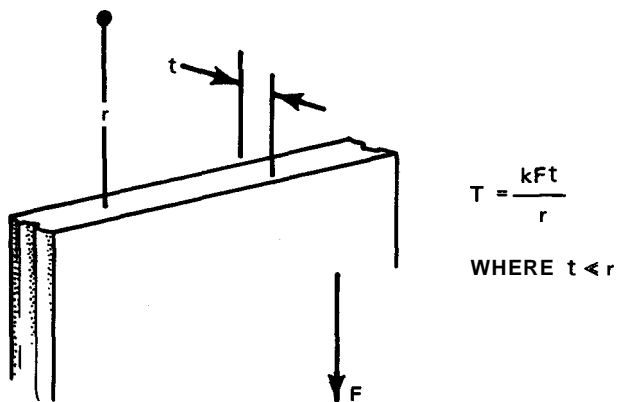

Figure 31. Anomaly of Narrow Vertical Dike

A common point of ambiguity arises with such simplified schemes as these in the case of a dike which is nearly as wide as it is deep. In this case, the anomaly is approximated as something between a line of monopoles as above and a sheet of monopoles as shown in the following. Moreover, as the dike is even wider than its depth, it can be approximated simply by 2 faulted contacts with 'no anomaly' in between.

For a semi-infinite slab of material such as a rock surface of great thickness and breadth in a non-horizontal field, the flux lines do not vary in direction or density above the slab, therefore the field does not vary at all with distance to its surface (similar to the limit of the spherical dipole above where  $R=r$ ) so that

$$T = \frac{M}{r^0} = \frac{2\pi I}{r}, \text{ or } T = 2\pi kF$$

which is useful in estimating the magnitude of the anomaly at a vertical fault (see Figure 32). For example, consider two rock types at a vertical contact of  $k = 10^{-3}$  and  $k = 10^{-5}$  for an effective susceptibility contrast of  $k = 10^{-3}$  ( $10^{-5} \approx 0$  relative to  $10^{-3}$ ) and where  $F = 50,000$  gammas. Thus

$$T = 2\pi \times 10^{-3} \times 5 \times 10^4 = 300 \text{ gammas}$$

If the rocks had  $k = 10^{-4}$  and  $10^{-3}$ , the effective susceptibility contrast would be

$$10^{-3} - 10^{-4} = 9 \times 10^{-4} - 10^{-4} = 8 \times 10^{-4} \text{ and}$$

$$T = 2\pi \times 8 \times 10^{-4} \times 5 \times 10^4 = 250 \text{ gammas}$$

*This simple example of two adjacent rock types is probably applicable in more instances in interpretation than any of the other geometries discussed above.*

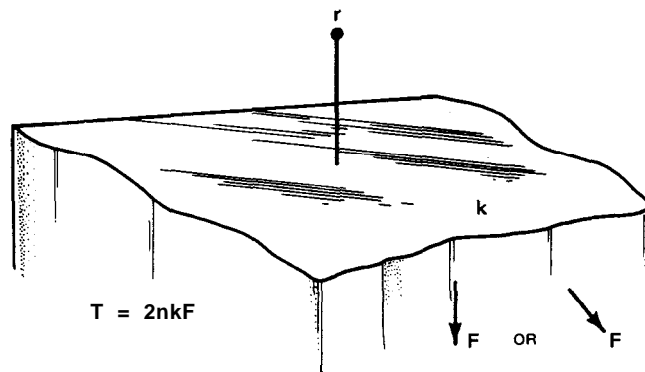

Figure 32. Anomaly of Semi-infinite Slab

#### Anomaly Depth Characteristics

In a very approximate fashion, the wavelength, or, effective width (or 'half-width' described in the following) of the anomaly and, with more accuracy, the width of certain characteristics of the anomaly such as slope, are measures of the depth to its source. However, recognition of the anomaly, the anomaly 'zero' and certain slopes would not only appear as different values as determined by different interpreters, but they also depend upon what is removed as the regional gradient. More objective criteria are used in some cases such as the nearly straight portions of a slope, and distances and angles between inflection points, peak values and other anomaly characteristics.

#### Anomaly Width

In general, the anomaly width as shown in Figure 33 is on the order of 1 to perhaps 3 times the depth. Thus, when an anomaly appears to have a width as such of 100 feet, it is definitely not produced by a source at 1000 feet or at 10 feet, but more likely by a source between 30 and 100 feet deep (or distant). Such criteria, approximate as it is, is nevertheless useful for cursory interpretation of profiles and maps.

#### Anomaly Depth Estimation

Much is written on the variety and relative merit of methods for estimating the depth to the source of anomalies. Since the magnetometer is primarily a tool for subsurface mapping and detection, it follows that determination of the depth as well as edges of bodies is important in its application to geological exploration and search. The basis for depth determination is presented here in brief which, together with the foregoing background on anomaly behavior, should allow one to at least appreciate how a variation in depth affects an anomaly. In most cases, one needs only to apply this knowledge qualitatively through visual inspection of a profile. Whatever the requirement, depths may be estimated by visual inspection, several rules of thumb, modeling (i.e., calculation of assumed source and comparison with observed), measured gradient techniques (see Chapter VIII), or various computer-oriented procedures. As was demonstrated earlier, a given anomaly could have an infinite number of possible sources and source depths, but the realistic models that are assumed usually produce maximum depth estimates.

Knowledge of the depth of a particular formation or source may have considerable geological significance as it determines the nature of configuration of a forma-

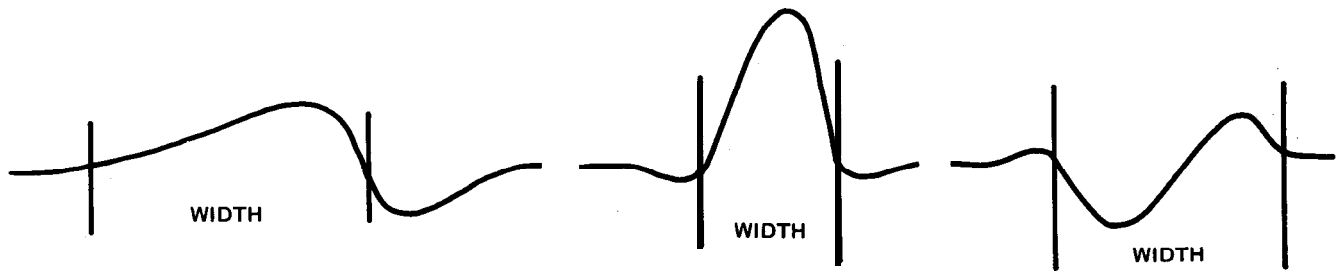

Figure 33. Anomaly 'Width'

tion, the slope of its surface and its discontinuities. The depth to various points on the surface of crystalline rock or magnetic basement allows one to map that surface and its topography and structures to depths exceeding 30,000 feet and to infer thickness of sediments or conformable sedimentary structures above it for exploration of petroleum, sedimentary ores, placer deposits or groundwater. Areas underlain by pediment or other sedimentary deposits may be ruled economic or non-economic according to depth. The depth to ore deposits associated with pyrrhotite, magnetite or ilmenite may be estimated as an aid to a drilling program or even for estimation of total tonnage of magnetic iron ore deposits. Black sand deposits of rutile, zircon, monazite, diamonds, gold, platinum, etc. are often associated with other high density, very resistant yet magnetic minerals, namely, magnetite or ilmenite. The depth to objects of search whether buried iron or man-made structures is invaluable in guiding the subsequent excavation efforts.

**Identification of Anomaly**

The anomaly of interest must be identified and discriminated against the obscuring effects of others. Recognition of the anomaly itself is usually the most difficult aspect of depth determination because of the composite effects of multiple sources, sources at various depths and at various distances in any direction from the magnetometer. Only the net effect of all anomalies are measured by the magnetometer since it has no inherent discrimination ability at the disposal of the operator. The anomaly should be inspected to ascertain the probable source and, if complex, the possible combination of sources. For example, a wide, shallow dike will appear as two anomalies which may or may not coalesce depending upon the relative width and depth. A very broad anomaly or regional gradient (described in Chapter IV), is usually caused by anomalies which are extremely deep or distant or by the normal variation in the earth's magnetic field. If one wishes to remove this gradient, it can be done either by drawing a straight line through the non-anomalous portions of the profile (away from the anomaly of interest) or by drawing a very smooth but broad wavelength curve through the data of much longer wavelength than any anomalies of interest. This regional gradient or background is then subtracted from the anomaly and the remaining, or residual anomaly, replotted. It is this anomaly which is then interpreted for either depth or for amplitude or general configuration of sources as described in Chapter IV.

**Fall-Off Rate**

The variation of anomaly amplitude with distance, or fall-off rate, is important in the interpretation of anomalies for it relates the anomaly to depth, it describes in a general way the configuration of the source, and it

assists in determining susceptibility and mass of the causative magnetite. Recall that the anomaly from a dipole varies as  $\frac{1}{r^3}$  and that of a monopole as  $\frac{1}{r^2}$ . The fall-off rate, in actual practice, does not involve precisely such factors or exponents but, in fact, is typically  $\frac{1}{r^{2.5}}$ ,  $\frac{1}{r^{0.6}}$

etc., or even  $\frac{1}{r^0}$  as described above. In other words,

various configurations of dipoles, monopoles, lines and sheet-like distributions of these poles constitute a continuous series of fall-off rates even in the vicinity of a single anomaly as one is much closer or further away from the source.

Representing various geologic sources as simple prismatic bodies, one may assume the following fall-off rates: a dipole will be produced by a source all of whose dimensions are small (less than  $\frac{1}{10}$  compared to the distance between the source and magnetometer). Such a body is rarely seen in nature except as a very confined, usually magnetite-rich ore body. A monopole varying as  $\frac{1}{r^2}$  will be produced by a long, thin, vertical prism, such

as a narrow vertical intrusive in steeply dipping fields or a horizontal cylinder striking N-S in equatorial fields (e.g., a N-S anticlinal structure on the basement, one end of which is near the magnetometer). A line of dipoles is produced by a long, horizontal cylinder magnetized through its short dimension as in steeply dipping latitudes or striking E-W in equatorial regions. Such a cylinder will also vary as  $\frac{1}{r^2}$ . A line of monopoles would

effectively be observed near one edge of a dike dipping in the direction of the field and would vary approximately as  $\frac{1}{r}$ . At a point above a horizontal semi-infinite sheet, the field would vary inversely as  $\frac{1}{r^0} = 1$ , which is another

way of expressing the fact that the field does not vary at all with distance from a horizontal semi-infinite sheet of monopoles or dipoles. A wide vertical dike in a steep field or the edge of a fault might represent combinations between a line of dipoles or sheet-like distribution of monopoles and may thus vary as  $\frac{1}{r^*}$  or  $\frac{1}{r^{0.5}}$  or less. Figure 34 indicates these variations.

**Assumptions on Maximum Amplitude and Depth Estimates**

Unless the remanent magnetization is actually measured, it is generally disregarded, and only the induced magnetization and susceptibility are utilized in these expressions. The magnetic anomaly calculated from these

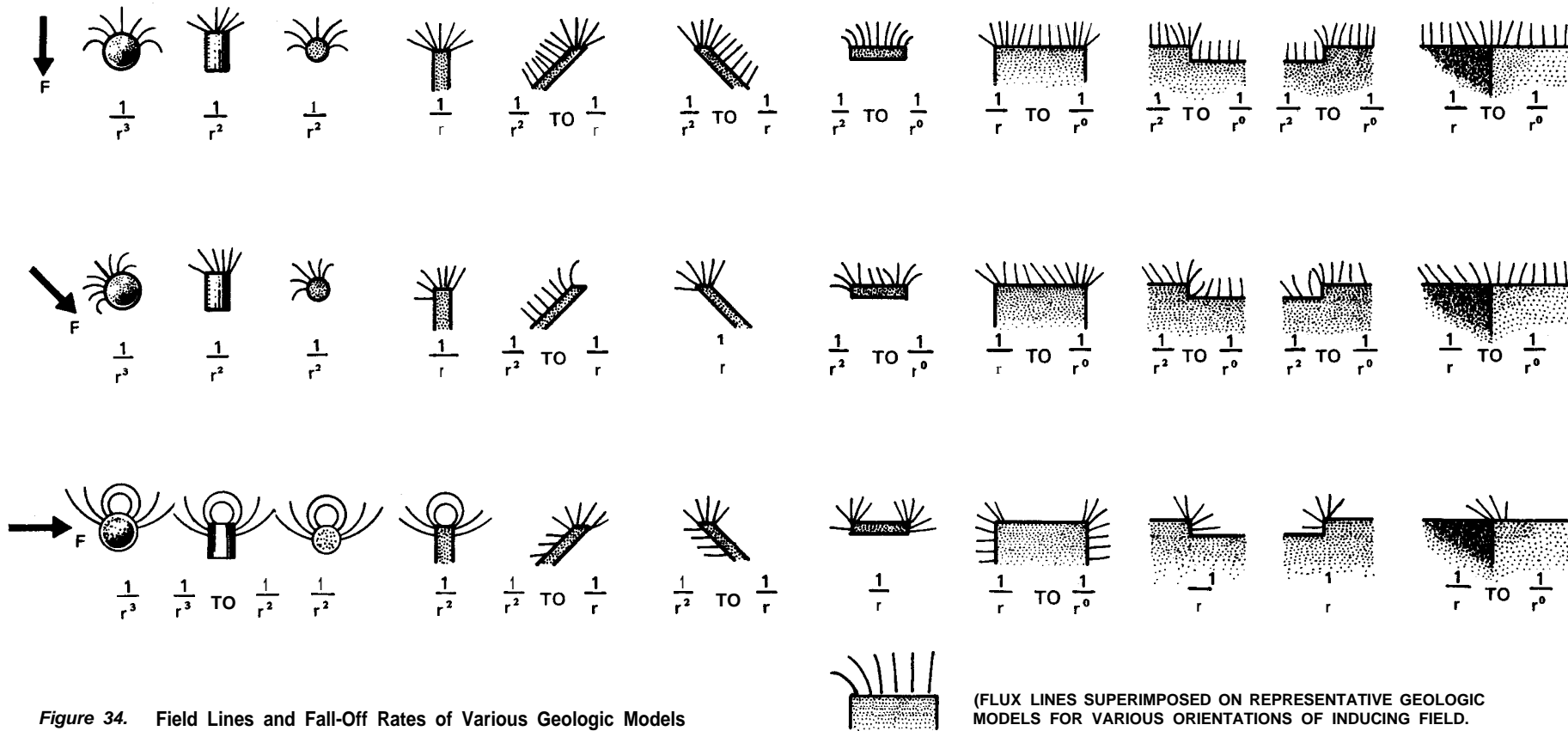
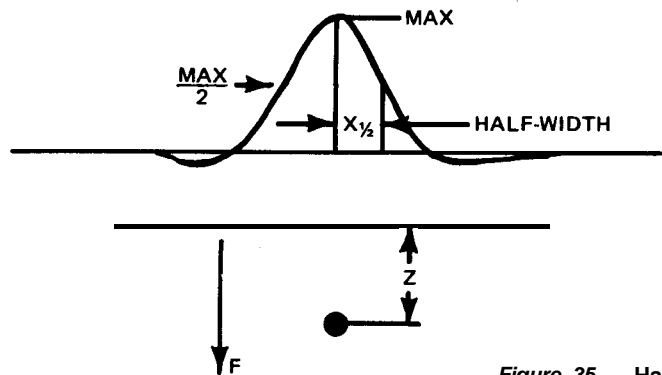

Figure 34. Field Lines and Fall-off Rates of Various Geologic Models

(FLUX LINES SUPERIMPOSED ON REPRESENTATIVE GEOLOGIC MODELS FOR VARIOUS ORIENTATIONS OF INDUCING FIELD. ANOMALY AMPLITUDE PROPORTIONAL TO INDICATED TERM OF  $1/r^n$ .)



- SPHERE (DIPOLE)  $Z = 2X_{1/2}$
- VERTICAL CYLINDER (MONOPOLE)  $Z = 1.3X_{1/2}$
- EDGE OF NARROW DIKE  $Z = X_{1/2}$   
(LINE OF MONOPOLES)
- HORIZONTAL CYLINDER  $Z = 2X_{1/2}$   
(LINE OF DIPOLES)

Figure 35. Half-width Rules - Vertical Field

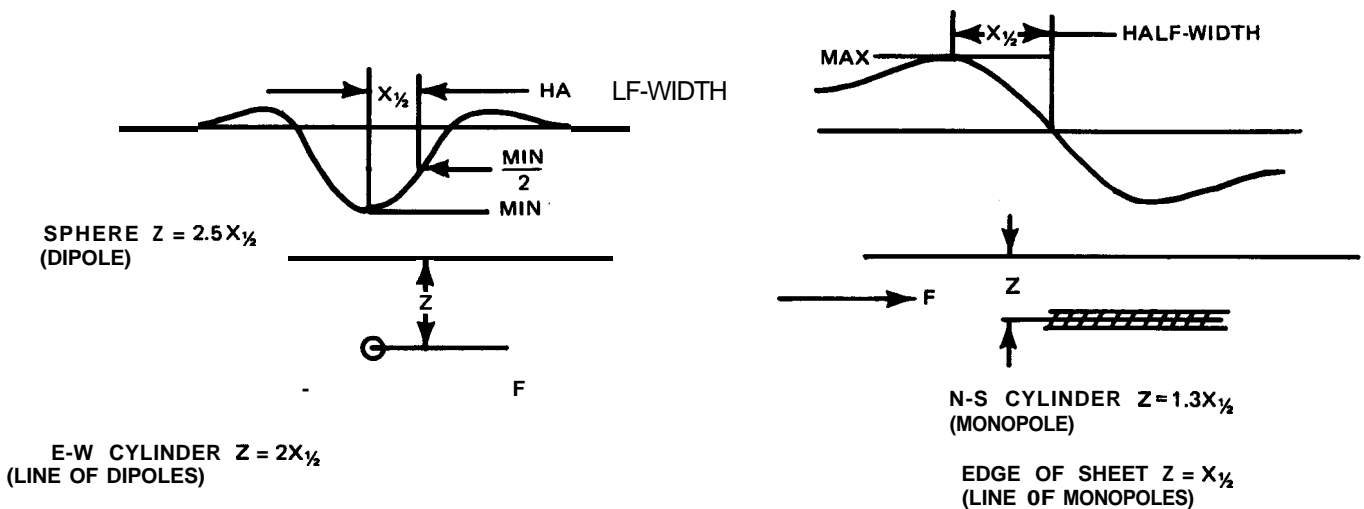

Figure 36. Half-width Rules - Horizontal Field (Equatorial)

highly simplified expressions represents the maximum amplitude from the local zero, non-anomalous field to the positive peak value in the northern and southern latitudes and to the minimum negative value in equatorial regions. It does not represent the peak-to-peak value which includes both positive and negative portions of the anomaly signature. The depth estimates derived from any of the techniques described are seldom more accurate than 10% of the actual depth and sometimes as poor as 50%. By theory most of the estimates are maximum estimates so that the actual source will actually be at a shallower depth. Moreover, the 'poles' or source described frequently throughout their chapter are within the geologic body or object of search and not simply on the surface; therefore, such depths are again maximum depths.

**Half-Width Rules**

In vertical or horizontal fields, it can be shown, from the previous expressions for dipoles and monopoles, that for simple forms of anomaly sources, the depth to their centers is related to the half-width of the anomaly. The half-width is the horizontal distance between the principal maximum (or minimum) of the anomaly (assumed to be over the center of the source) and the point where the value is exactly one-half the maximum value (see Figure 35). This rule is only valid for simple-shaped forms such as a sphere (dipole), vertical cylinder (monopole), and the edge of a narrow, nearly vertical dike (line of monopoles) in the polar regions. At the magnetic equator, the half-width rules are somewhat different with the sphere remaining unchanged, an E-W horizontal cylinder being a line of dipoles, a N-S cylinder being a monopole, and the edge of an E-W striking horizontal sheet representing a line of monopoles. The rules presented in Figure 36 apply according to the corresponding array of poles and in the case of the latter two, the half width being the horizontal distance between the point of maximum (or minimum) and zero anomaly. The half width rules are derived from formulae given above in "Dipole and Monopole Signatures in Vertical and Horizontal Fields".

**Slope Techniques**

Perhaps the most commonly used set of methods for estimating depth are those which utilize criteria involving the measurement of the horizontal gradient or slope at

the inflection points of the anomaly. Based upon empirical observations utilizing computed models, these slopes are measured according to the horizontal extent of the 'straight' portion of the slope (see Figure 37) or the horizontal extent determined by different combinations of the tangent or slope at the inflection point, maximum of the anomaly and half slopes, etc. Each of these horizontal distance measurements when multiplied by an empirically-determined factor equals the depth to the top of the anomaly source. (The straight-slope, for example, is multiplied by a factor between 0.5 and 1.5). Detailed explanations of these methods are available in the references cited.

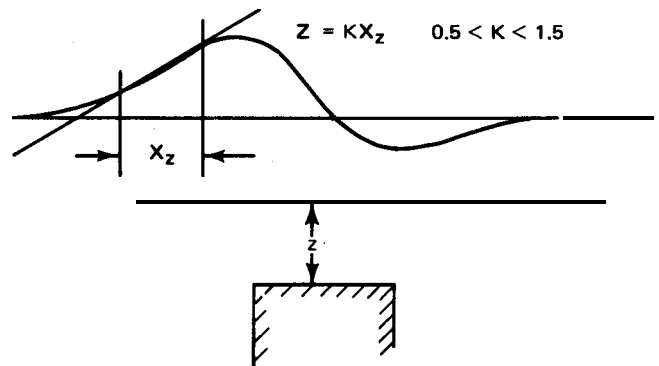

Figure 37.

**Other Depth Estimating Methods**

Modeling techniques require that one examine the observed anomaly for its likely source configuration. A model is assumed, the anomaly calculated, compared with the observed and repeatedly altered until a satisfactory fit to the observed data is finally achieved, with such work usually performed on a computer. Other computer-oriented depth estimating methods include programs utilizing Fourier and Hilbert transforms, convolution and other semi-automated programs which are usually applied to large volumes of data. Gradiometer measurements made with sensors at two points usually vertically arranged can also be used for depth estimates (see Chapter VIII).



### Interpretation Summary

Interpretation is facilitated if one can thoroughly familiarize himself with how and why a given source produces an anomaly in the earth's field, the nature of total field measurements and the general behavior of an anomaly signature with increasing depth. What at first may have appeared complex in the interpretation of field profiles and maps is more readily understood when the above phenomena are examined one at a time.

The first procedure that should be followed in the interpretation of a given profile is to focus on the anomaly width and shape and attempt to construct at least a mental image of the source in realistic geologic terms (or object in the case of search) and its depth. Use the eye to discriminate against noise and the regional gradient or filter by one of the suggested techniques. Anomalous horizontal gradients should then be used, for lack of any other specific criteria, as an indicator of the edge of subsurface structures producing a magnetization contrast. Most anomalies on any given profile or map represent a simple contrast in magnetization or lithology. i.e., the edge of a body. Attempt to correlate such features on adjacent lines or interpret them as contacts on a total intensity contour map. The cessation,

displacement or interruption of otherwise long or continuous features may also represent significant geologic structural information. However, one must realize also that a magnetic survey is only able to map a contact where there is a magnetization contrast so that, for example, different lithologies on either side of a long continuous fault will be mapped only in segments where such contrasts occur.

Changes in the character of the short wavelength anomalies (noise) may also represent mappable information if one is careful to evaluate their typical depth so as not to be mapping irrelevant soil anomalies. Negative anomalies arising from features of locally lower magnetization are as important geologically as the more common positive anomalies. Furthermore, the most geologically *significant anomalies on a given map are probably the more subtle ones and not necessarily the largest, most prominent anomalies*. Lastly, the total intensity profiles and maps are not an end in themselves, but are rendered usable only when expressed in terms of geology (or objects of a search). The more geological information one has (or size, magnetic or depth information for an object of search) the more valuable the total intensity data becomes and vice-versa.

## VI.

# MAGNETIC SUSCEPTIBILITY, MAGNETIZATION AND MAGNETIC MOMENT MEASUREMENTS

### introduction

Magnetic susceptibility and magnetization of rocks and the permanent and induced moment of objects can be measured in the field using the component measuring properties of the proton magnetometer. The procedure, at its simplest, involves rotating a sample about a point close to the magnetometer sensor on a line which is in the direction of the earth's total field and passes through the center of the sensor. Measurements of the maximum and minimum anomaly observed and the value of the field without the sample present is sufficient to allow reasonably accurate calculation of magnetic susceptibility and induced and remanent magnetization (and its direction) of all but the weakly magnetized rocks and the magnitude and direction of the magnetic moment of objects.

### Applications

Knowledge of the magnetic susceptibility is useful in ground follow-up of aeromagnetic surveys to ascertain the source of observed anomalies, to determine possible magnetite-associated mineralization, and in mapping several rock units as a function of their susceptibility. Measurement of magnetization may also be useful in mapping certain members of volcanic formations, par-

ticularly where magnetization reversals are present. Measurement of the orientation of the permanent magnetization of rocks provides the basis for paleomagnetic measurements for the study of the changes and reversals of the earth's magnetic field. Although such studies require the precise direction of the remanence, it may nevertheless be useful to make more numerous measurements easily and in the field using a proton magnetometer if only to a few degrees accuracy. Additional objectives of such measurements for magnetic moment apply to search applications for buried or sunken ferromagnetic objects as described in the following section (VII) where such measurements can determine the estimated anomaly from certain objects of interest and thereby aid in the planning for such a survey. Magnetic compensation of objects is also facilitated by measuring the moments of both the magnetic object and the proper compensating magnet to avoid laborious cut-and-try techniques. As yet another application of such measurements, it is possible to classify or identify certain types of objects or rock types or their specific identity within a class of magnetic objects merely by unique combinations of permanent magnetization, induced magnetization, the ratio of these, the relative direction of these magnetizations, their variability, etc.

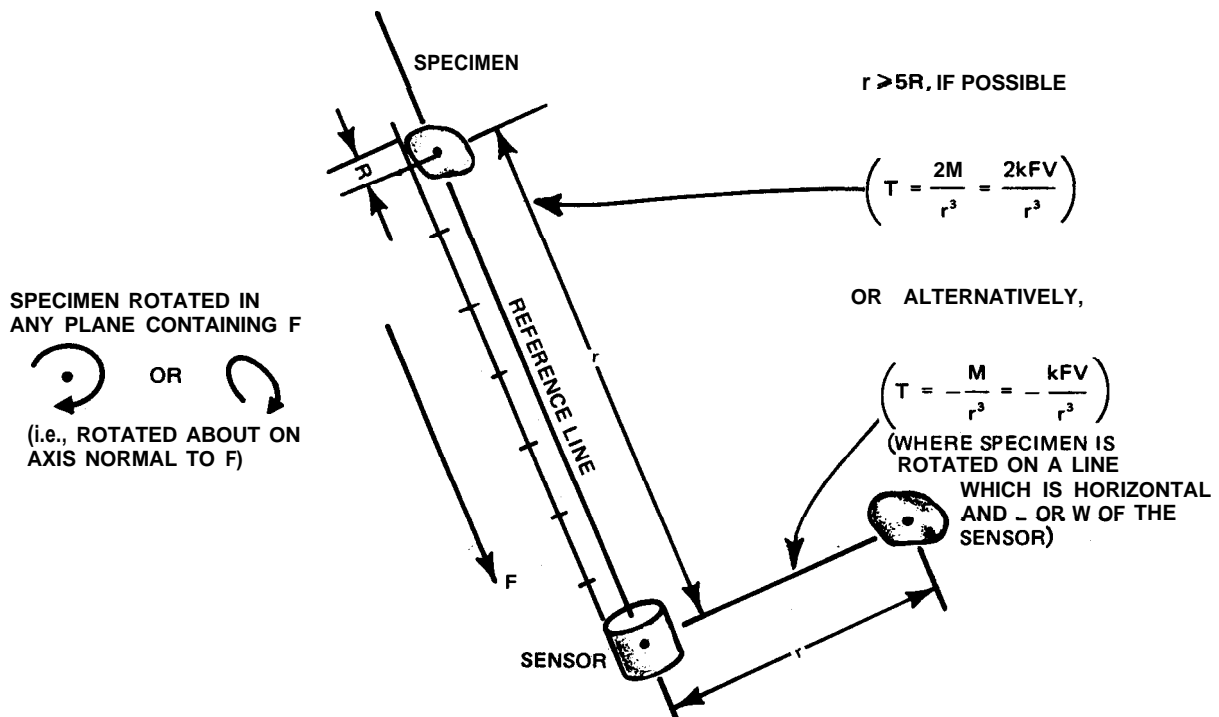

Figure 38. Schematic of Rotation of Specimen for Measurement of Magnetic Properties

**Procedures**

The first step in making such measurements requires that the sensor be placed in a fixed position in a magnetically clean area. A string, rod, or other non-magnetic line is then placed adjacent to the sensor such that it is aligned with the earth's magnetic field vector and allows rotation of a fist-size or larger rock specimen, about a point at a known distance from the center of the magnetometer sensor and along a line, to be called the *reference line*, containing the sensor, specimen and the earth's field vector. (NOTE: The specimen can be on either side of the sensor along this line; the measurements and procedures are unchanged.) Such an arrangement is shown in *Figure 38*. Marks should be placed along this reference line at perhaps distances of 10, 25, 50 and 100 centimeters from the center of the sensor. (Centimeters must be the units employed as the measurement objectives of magnetization, susceptibility, magnetic moment, etc. are always expressed in cgs.)

The earth's field direction can be determined from a table of inclination such as appears in *Figure 3* in Chapter II. The earth's field direction is oriented as the angle of inclination measured downwards from the horizontal in a north direction and within a vertical magnetic north-south meridional plane. A dip needle can also be used to determine this direction. An alternative way of determining the precise direction of the earth's field vector using the magnetometer itself would be as follows: affix a non-magnetic rod to the sensor in such a way that it passes through the center of the sensor (usually the magnetometer staff is such a rod). At a point perhaps 30 to 50 centimeters away from the sensor, place a needle or other very long but thin ferromagnetic (steel) object (it does not necessarily have to be permanently magnetized) along the axis of the rod. Take this rigid arrangement of staff, sensor and needle (small dipole) and slowly re-orient the staff until a maximum or minimum total field intensity reading is obtained. The orientation of the staff at the maximum or minimum will be precisely along the earth's field vector. (NOTE: for a soft iron needle with no permanent magnetization there will also be a minimum at right angles to the field, but it is presumed that at least the general direction of the field is known)

Ideally, the sample should be as equi-dimensional as

possible and should be at a distance of 5 times the diameter or greater if the approximation of a dipole is to remain valid. However, the size of the sample, distance from the sensor, and the maximum possible anomaly at the magnetometer are all compromises and for low susceptibility samples, a useful measurement can still be obtained when the sample is nearly in contact with the sensor.

**Random Sample Rotation for Magnitude Only**

After assuring that anything moving is magnetically clean, obtain a hand specimen and hold it at arm's length away or more (at least 3 times further than the measurement distance,  $r$ ) from the magnetometer sensor and obtain the reading,  $T_0$ , with the sample thus absent. Then bring in the sample to a point perhaps 15 centimeters or at some other known distance from the sensor in order to cause a change of at least several times greater than the basic resolution of the magnetometer. Obtain readings from numerous random orientations (say, every  $45^\circ$  of rotation) of the specimen if only susceptibility and magnitude of remanent magnetization is desired. As a more systematic procedure, orient the sample every 45 degrees about an axis normal to the reference line. Then rotate the sample 90 degrees about the reference line and rotate it again every 45 degrees. Note the maximum value,  $T_{max}$  and the minimum value,  $T_{min}$ , then remove the sample and once again check to see that the same reading,  $T_0$ , is obtained as observed at the start of the test. If the same reading is not obtained (or within 2 gammas), conduct the measurements over. If one were to plot such measurements, they would appear as in *Figure 39*.

Next, measure the diameter of the sample which should be as equi-dimensional or spherical as possible and which can be made so by taking a geology pick and hammering off the portions of the rock to produce an approximately equi-dimensional sample. Measure the average diameter,  $D$ , of the specimen and the distance,  $r$ , between the center of the specimen when rotated and the center of the sensor. *These five parameters,  $T_0, T_{max}, T_{min}, D$ , and  $r$ , are all that is needed in the following formulae to calculate both magnetic susceptibility and magnetization or the induced and permanent magnetic moments of a small object.*

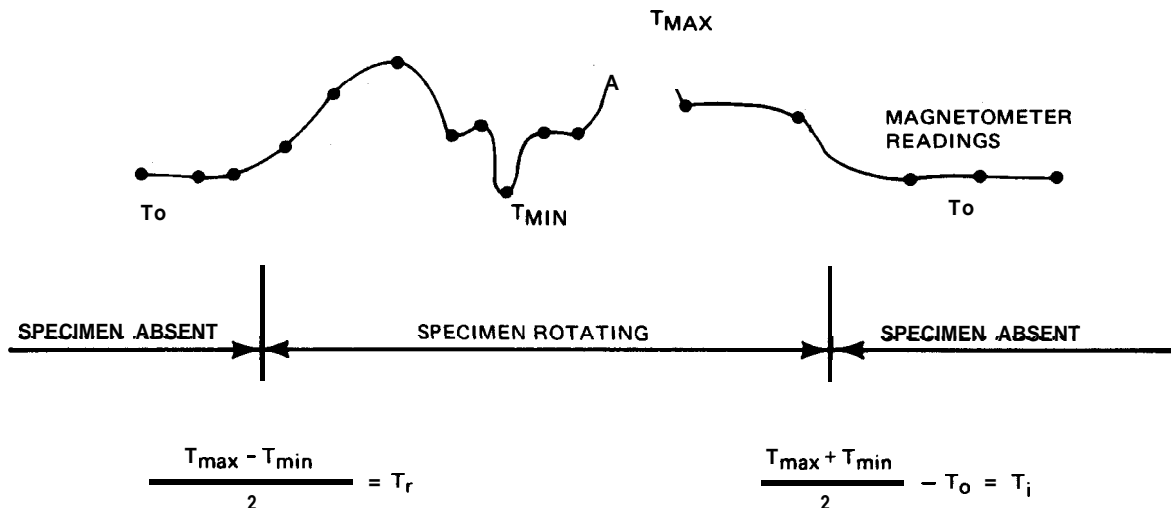

*Figure 39.* Typical Readings Obtained During Rotation of Specimen Near Sensor

For the remanent magnetization information

$$T_r = \frac{T_{\max} - T_{\min}}{2} = \frac{2 M_r}{r^3} = \frac{2 l_r^{4/3} \pi \left(\frac{D}{2}\right)^3}{r^3}$$

expressed in centimeter-gram-second (cgs) units and noting that  $F$ ,  $T_r$ ,  $T_{\min}$ , and  $T_{\max}$  are to be expressed in gauss (1 gamma =  $10^{-5}$  gauss).  $M_r$  is the permanent or remanent magnetic moment in cgs units. All other terms are previously defined. Therefore

$$l_r = \frac{3}{2\pi} \left(\frac{r}{D}\right)^3 (T_{\max} - T_{\min})$$

and

$$M_r = \frac{r^3}{4} (T_{\max} - T_{\min})$$

where  $l_r$  and  $M_r$  are the remanent magnetization per unit volume and permanent dipole magnetic moment respectively.

For the induced parameters,

$$T_i = \frac{T_{\max} + T_{\min}}{2} - T_0 = \frac{2 M_i}{r^3} = \frac{2 l_i^{4/3} \pi \left(\frac{D}{2}\right)^3}{r^3}$$

and

$$l_i = k F$$

Thus

$$k = \frac{3}{2\pi F_0 D} \left(\frac{r}{D}\right)^3 (T_{\max} + T_{\min} - 2 T_0)$$

$$\text{and } M_i = \frac{r^3}{4} (T_{\max} + T_{\min} - 2 T_0)$$

are the susceptibility per unit volume and the induced dipole moment respectively. If the specimen is not equi-dimensional or nearly so, there will be a small error in both  $k$  and  $M_i$ .

For magnetometers with a sensitivity of 1 gamma or 0.25 gamma, the smallest magnetic susceptibility that can be measured using such techniques is on the order of  $2 \times 10^{-5}$  or  $5 \times 10^{-6}$  cgs units, respectively, for a large specimen adjacent to the magnetometer sensor. Attention should be paid not to bring very high magnetic susceptibility ( $10^{-3}$  cgs or greater) samples close to the magnetometer sensor for it would degrade the signal. High magnetic susceptibility specimens or ferromagnetic objects can be rotated at greater distances, anyway, perhaps 100 centimeters from the sensor and low susceptibility specimens at 15 centimeters or even closer. If only approximate susceptibility is required in the field, it is even possible to rotate the sample, estimating the distance of rotation from the sensor, estimating the direction of the earth's field after knowing this value from maps (the direction does not change appreciably over hundreds of miles), and then estimating the diameter of the specimen. Such a measurement should not require more than one minute to obtain a value within a factor of 2 or better for both the susceptibility and remanent magnetization.

### Systematic Rotation for Magnitude and Direction

In contrast to this highly simplified and approximate method for measuring susceptibility and remanent magnetization using the random orientation procedures outlined above, one may wish to obtain the values more systematically, more precisely and most important, to obtain directional information describing particularly the remanent magnetization and permanent moment. If

such is desired, the object is rotated in all three orthogonal planes to obtain the components and to separate the effects of the induced and permanent magnetizations. The magnitude of the induced perturbations for the orthogonal directions would be  $T_i$ , as before, since  $xT_i = yT_i = zT_i = T_i$ , the object is assumed to be spherical and with isotropic susceptibility; and  $xT_r$ ,  $yT_r$  and  $zT_r$  for the orthogonal components of the remanent perturbations.

These components would be obtained as follows: first rotate the object through  $360^\circ$  about any line normal to the reference line, i.e., earth's field. Note,  $T_0$ , the value of the field with no object present and the values at rotation positions  $90^\circ$  apart, namely,  $T_{90}$ ,  $T_{180}$ ,  $T_{270}$  and  $T_{360}$ . For these measurements one has

$$xT_r = \frac{T_{180} - T_{360}}{2}, \quad yT_r = \frac{T_{90} - T_{270}}{2},$$

and

$$T_i = \frac{T_{360} + T_{180}}{2} - T_0 = \frac{T_{90} + T_{270}}{2} - T_0$$

The object is then removed and reinserted on the reference line so that the former axis of rotation (in this case, the  $z$  axis) is now parallel to the field. Measure this field value and one at  $180^\circ$  from this position to get

$$zT_r = \frac{T_{z=360} - T_{z=180}}{2} \quad \text{and if one wishes, the}$$

$$\text{redundant value } T_i = \frac{T_{z=360} + T_{z=180}}{2} - T_0$$

The calculations of  $k$ ,  $M_i$  and  $l_i$  are performed as described above. The magnitude of the remanent moments, however, would then be

$$xM_r = \frac{r^3}{2} xT_r, \quad yM_r = \frac{r^3}{2} yT_r \quad \text{and} \quad zM_r = \frac{r^3}{2} zT_r$$

and the total moment,  $M_r = (xM_r^2 + yM_r^2 + zM_r^2)^{1/2}$

The direction of the remanent moments would be given by the direction cosines  $\cos\alpha$ ,  $\cos\beta$ , and  $\cos\gamma$  where

$$\frac{xM_r}{M_r} = \cos\alpha, \quad \frac{yM_r}{M_r} = \cos\beta \quad \text{and} \quad \frac{zM_r}{M_r} = \cos\gamma.$$

The remanent magnetizations,  $xl_r$ ,  $yl_r$  and  $zl_r$ , also defined as dipole moment per unit volume, are in the same direction as their respective moments and are given by

$$xl_r = \frac{xM_r}{V}, \quad yl_r = \frac{yM_r}{V} \quad \text{and} \quad zl_r = \frac{zM_r}{V}$$

$$\text{Therefore } l_r = (xl_r^2 + yl_r^2 + zl_r^2)^{1/2}$$

For shapes other than spheres other formulae must be used for the geometric factors. If the magnetization is larger than, say, 0.1 cgs, demagnetization factors must also be considered which are usually available in tables expressed in terms of the length-to-diameter ratio and direction of magnetization. Demagnetization arises from the fact that the object itself creates an induced field, which as pointed out earlier, opposes the ambient field

in the region to the side of the object (with respect to the field direction). The inducing field is thus smaller and the magnetization less than would be predicted without accounting for the effects of this demagnetization.

### Dipole in Earth's Field

For measurements which are not precisely along the "reference" line or normal to it, it may be instructive to examine the properties of the dipole and properties of a permanent or induced dipole located within the vicinity of a total field magnetometer (see also Chapter V).

The field of a magnetic dipole can be expressed in terms of its tangential and radial components,  $T_\theta$  and  $T_r$  where

$$T_\theta = \frac{M}{r^3} \sin \theta$$

and

$$T_r = \frac{2M}{r^3} \cos \theta$$

and where  $\theta$  is the angle between the dipole axis and  $r$  the line between the dipole and point of measurement as in *Figure 40*. The magnitude of the field intensity of the dipole can thus be expressed as

$$T = (T_\theta^2 + T_r^2)^{1/2} = \frac{M}{r^3} (1 + 3 \cos^2 \theta)^{1/2}$$

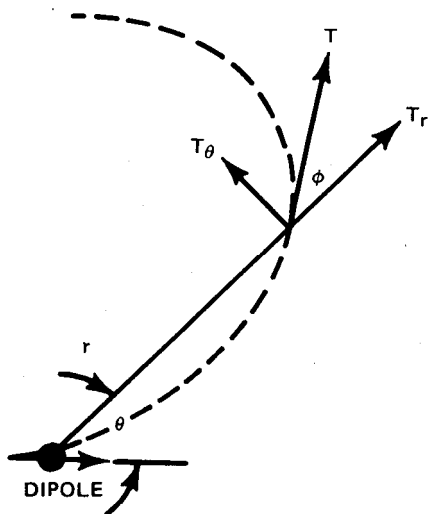

Figure 40. Terms Used in Calculating Effect of Dipole on Earth's Field.

The total field perturbation  $TF$  due to a magnetic dipole at an angle  $\beta$  to the earth's field as shown in *Figure 41* is simply the component of the dipole field in the direction of the total field or

$$TF = \text{comp}_F T = T \cos (\phi + \theta + \beta)$$

and from the above geometry of a dipole

$$TF = \frac{M}{r^3} (1 + 3 \cos^2 \theta)^{1/2} \cos \left[ \tan^{-1} \left( \frac{\tan \theta}{2} \right) + \theta + \beta \right]$$

### Non-Spherical Object Rotation

An entirely different situation occurs when the object is not equi-dimensional but possesses a high length-to-diameter ratio as in the case of a long, narrow cylinder.

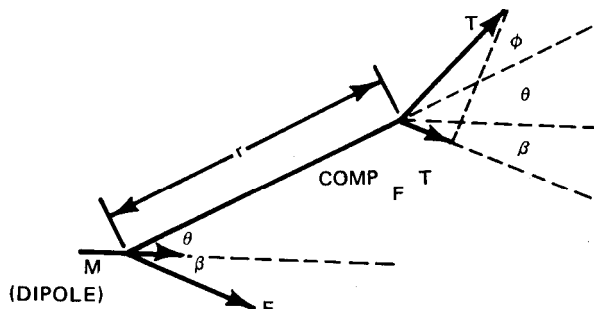

Figure 41. Reference Diagram for Estimating Effect of Dipole in the Plane of the Earth's Field

In this case, the induced field tends to align itself with the long dimensions of the object in a positive sense 90° or less in the direction of the ambient field for ferromagnetic objects. Such an object, if rotated end-over-end in a plane containing the ambient field, will produce a dipole moment which is nearly parallel to the axis of the object which is always positive and which varies in magnitude from the maximum parallel to the field to a minimum at right angle to the field. In an object which possesses both permanent and induced magnetic moments and in addition has a high length-to-diameter ratio, the effects are algebraically additive, but at any one orientation, nevertheless, appears as a dipole whose direction is the vector sum of the induced and permanent dipole moments.

The nature of the variation of intensity with respect to the rotations described will differ considerably depending upon the relative magnitude of the induced and permanent magnetization and upon the shape of the sample. Typical situations are expressed in *Figure 42*. All rotations are shown as they would appear if they were rotated about one point on the reference line containing the earth's field except as noted for the last example.

In the above procedures for measuring moment, one may note that all measurements are made along the line containing the earth's field. It is also possible to make such measurements magnetically east or west in a horizontal line from the sensor (see *Figure 38*). However, as it may be noted from the expression for the dipole moment and from the properties of the dipole outline in Chapter V, the total field perturbation will be only one-half that which would be observed as suggested above on a line containing the sample, sensor and earth's field. Furthermore, a positive magnetization or increase in magnetization from a sample rotated east or west of the sensor will cause an inverse effect or decrease in the field at the sensor as may be noted by the direction of the field lines at a point on a line normal to the axis of an induced or permanent dipole.

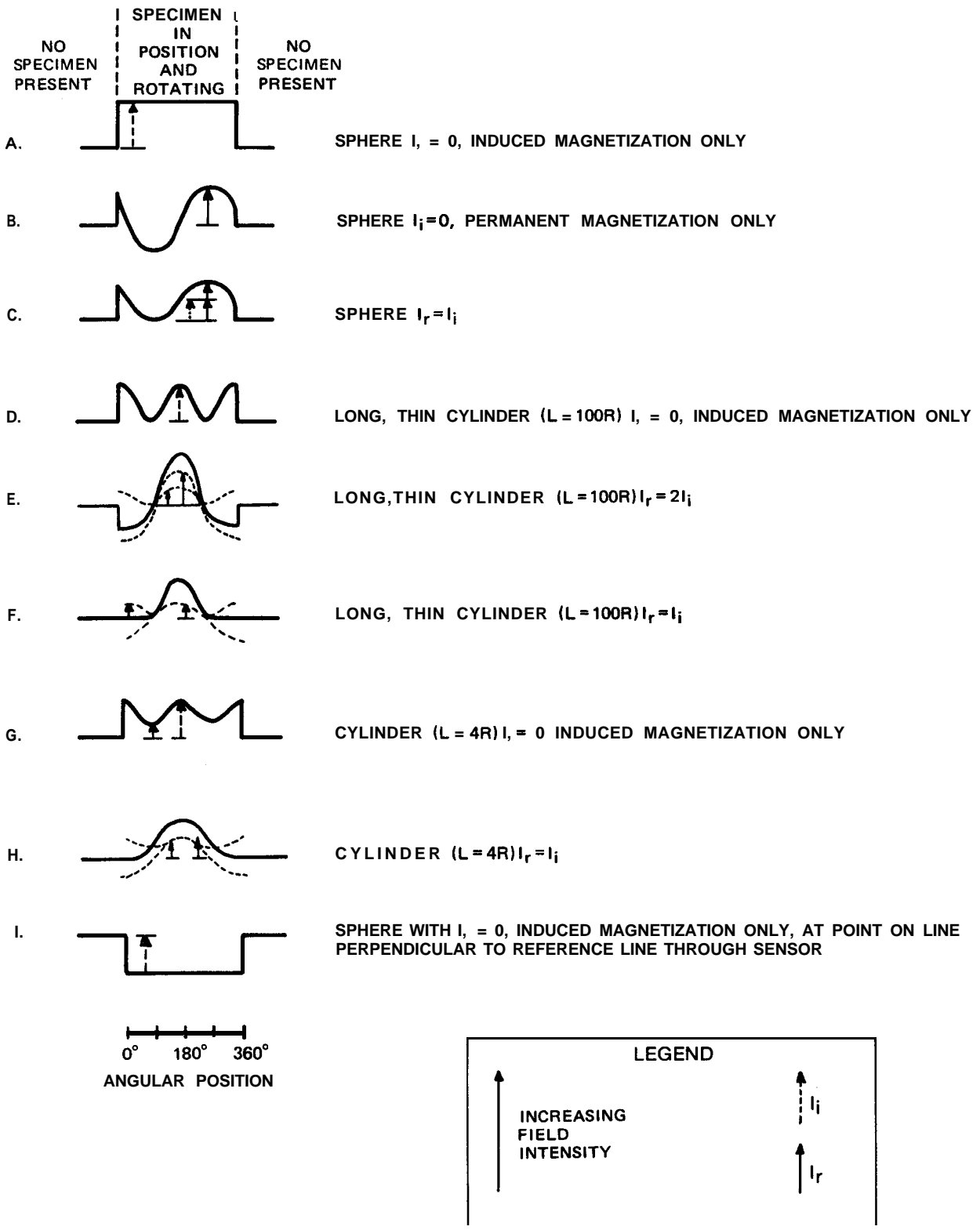

Figure 42 Total Field Variations Due to Rotation of Specimen Near Sensor

# VII.

## MAGNETIC SEARCH

### Introduction

Portable magnetometers can be very usefully applied to the task of finding objects which are buried, submerged, or otherwise hidden from view. An object can be found directly where it is itself magnetic, or where it may displace material which is otherwise uniformly magnetic. An object may, in some instances, be found indirectly when it produces a magnetic anomaly as a consequence of it being buried or emplaced. The object of a search may involve a man-made iron or steel object, an archaeological feature such as a brick, pottery, or tomb, or an intentionally buried magnet used for relocation purposes. In fact, among the diverse buried or sunken objects for which magnetometers have been used for their search are: culverts, pipelines, buried magnets, survey benchmarks, ships, vehicles, weapons, boat and aircraft engines, flight recorder, skis, buried skier with affixed magnets, rails, wellheads, machine tools, chain and anchors, tunnels, and the numerous items listed under Archaeological Prospecting below. In each of these cases, the objects could be found and their depth and mass estimated-but only if several conditions exist favorable to magnetic search procedures.

The techniques outlined here are primarily for portable magnetometer search applications on land except as noted. Marine search techniques involve other specific tactics, magnetometer sensors and cables designed for underwater use, and continuous recording displays.

### Determination of Object Magnetism

In assessing whether a magnetometer would be useful in a search, it *must first be determined whether the object* (direct or indirect) of the search is *truly magnetic*. Iron and steel, for the purposes discussed here, are the only metals which are ferromagnetic and, among these, stainless steel (300 series) can usually be considered non-magnetic. All naturally-occurring rocks and soils are weakly magnetic as a consequence of the amount of naturally-occurring magnetite present. Moreover, when such materials are heated, they attain a much higher magnetism upon cooling from a high temperature as would occur naturally in igneous rocks or artificially in kiln-baked clay. Magnets and coils carrying direct current are also detectable with a magnetometer. Buried chambers, tombs, some caverns, lava tubes and other subsurface voids are also detectable if they occur at a shallow depth in an otherwise uniformly magnetic material.

### Detectability

*The most important single factor affecting detectability with a magnetometer is the distance between the magnetometer and the object;* for, most anomalies in a search vary inversely as the cube of this distance, i.e.,  $T = M/r^3$ . Thus, any effort made towards reducing this distance greatly increases the likelihood and one's ability in finding the object of search. The next most important consideration is the amount of ferromagnetic material assoc-

iated with the object in contrast with the surrounding material. The effective magnetic mass (magnetic moment) of the object can be considered to be the degree of magnetism of the material times the volume of such material (e.g., a small magnet can be as magnetic as an automobile or a very large cavern).

The last significant criterion for detectability is the expected background magnetic noise arising from such sources as geology or man-made materials and electric current. In general, volcanic or dark-colored igneous rocks and soils derived from such rocks are very magnetic and render it difficult to detect a small, subtle anomaly. Common artificial sources of noise include power lines, direct current electric cables and trains (see Chapter IX), iron and steel debris and major cultural features including buildings, roads, fences, pipelines, reinforcing steel in concrete, etc. By and large, most sedimentary rocks (sandstone, shale, limestone, and their metamorphic equivalents, salt or fresh water or air do not alter the magnetic anomaly in any way; it is then simply the distance between the sensor and object that is important when buried in such materials.

### Magnetic Anomaly Signatures

The typical object of search *is* relatively small with respect to the distance between it and the magnetometer. Irrespective of its shape, *the object would then behave* as a *magnetic dipole* with all the characteristics described in Chapters V and VI. Typical dipole anomaly signatures (anomalies) expressed as profiles and contour maps at various orientations of the magnetic moment of the object and at various inclinations of the field appear in *Figure 43*. The anomaly shape expressed in *Figure 43* is primarily a function of the magnetic latitude and the direction of the permanent (remanent) magnetic moment. For example, given a magnetic profile or map over any dipole and some familiarity with total field magnetics one should be able to recognize the inclination of the field and perhaps also the orientation of the object as a dipole.

### Depth/Amplitude Behavior

As described in Chapter V, the anomaly will appear broader proportionately as the object is deeper or more distant (NOTE: the object is not always beneath a given traverse, but more than likely is at a distance to one side of the traverse. The distance between magnetometer and object herein referred to as depth may, in fact, only represent the 'closest approach' requiring perhaps another traverse to be truly 'over' the object). This anomaly width/depth characteristic of magnetic anomaly behavior serves as a means for determining the depth to the source which can be used to one's advantage in a search (see Chapter V). The amplitude of the anomaly will, as stated, also decrease as the cube of this distance. An example of anomaly depth and amplitude behavior is shown in *Figure 44* which can be extrapolated to the other signatures which appear in *Figure 43*.

INDUCED DIPOLE  
VERTICAL FIELD  
(NORTH OR SOUTH POLE)



INDUCED DIPOLE  
INCLINATION  $60^\circ$

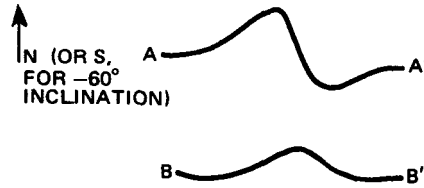
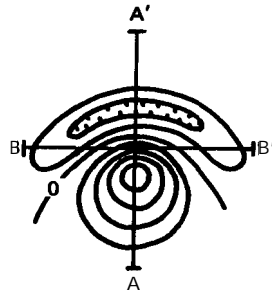

INDUCED DIPOLE  
EQUATORIAL FIELD  
(INCLINATION  $0^\circ$ )

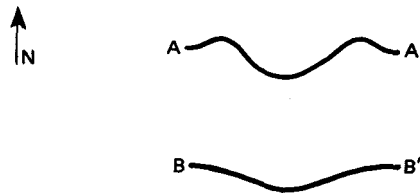
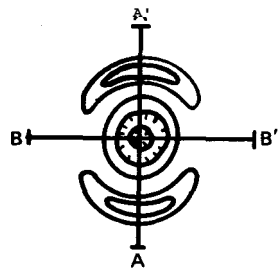

PERMANENT DIPOLE SIGNATURES (MOMENT NOT PARALLEL TO INDUCING FIELD, F)

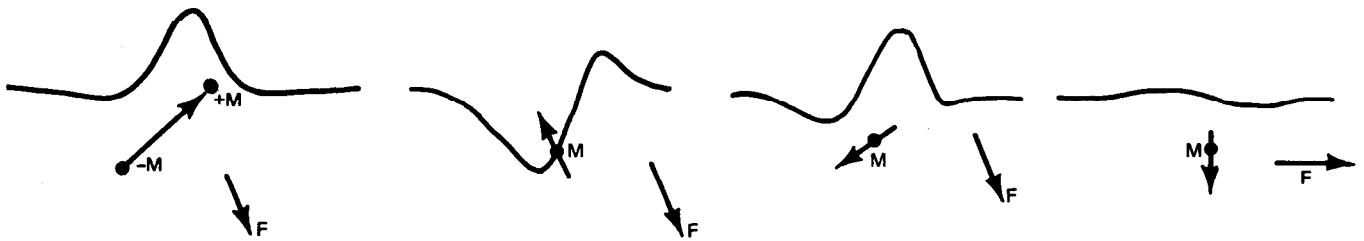

Figure 43. Total Intensity Signatures at Various Inclinations of the Field and for induced or Permanent Magnetic Moments

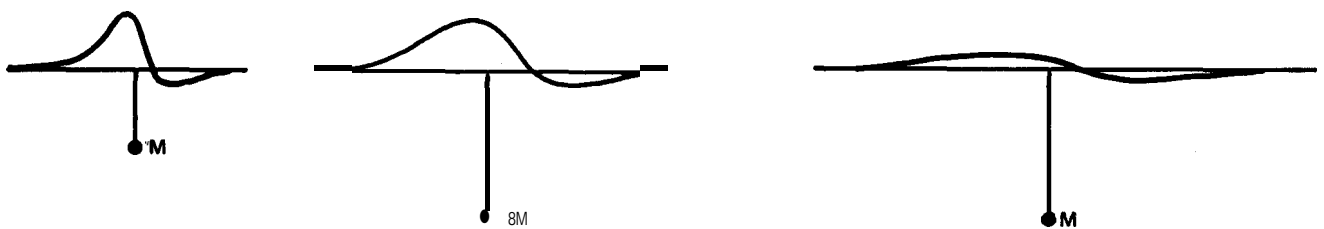

Figure 44. Depth/Amplitude Behavior of Dipole Anomalies



## Search Procedures

### Determination of Magnetic Moment vs. Search Grid vs. Resolution

The first consideration in conducting a search is to determine as much as possible what is magnetic, if anything, in the object or related to the object. Frequently, a similar object can be obtained and measured in the presence of a magnetometer at varying distances and orientations according to the methods outlined in the previous chapter. Remember that it is only the mass of ferromagnetic material and not the mass of the entire object that is of importance in magnetic search. Once the ferromagnetic mass is estimated, it is possible, using the simplified formulae below, to determine the maximum probable anomaly at various distances. Estimation of this maximum anomaly is important to determine whether the object is even detectable at the surface and, if so, how close the readings should be spaced on a traverse and the distance between adjacent traverses (spacing of the grid) if such a plan is considered. Ideally, one should lay out a regular grid covering the area such that the anomaly is readily detectable on any two adjacent traverses, i.e., there be some overlap in the detectability distance. To be sure, there are situations where very little is known about the object, whether it is even detectable at all magnetically, and the area in which it lies cannot for various reasons be covered at the proper grid interval.

It is important to realize that in order to recognize an anomaly, it must be several times larger than the sensitivity (resolution) of the magnetometer and the effective 'noise level' of the profile. If one has, say, a magnetometer of 0.25 gamma sensitivity and anomalies of 0.5 gamma due to the effects of surface soil, then the object would have to exhibit an anomaly of perhaps 1 gamma or more in order to be readily identified. This is even more important when the object is very deep for the anomaly is then very broad and may be confused with broad background changes due to deeper-seated geology or more distant anomaly sources. Therefore, a given object buried at 3 feet may have an anomaly width of 5 to 10 feet and may be detected if the anomaly is only 2 or 3 gammas in amplitude. Another object buried at 30 feet would correspondingly have an anomaly width of 50 to 100 feet, but may have to be 10 gammas in amplitude in order to be discernible in the presence of the normal background magnetic gradients.

#### Traverses

Several theoretically-derived search procedures have been devised which use spiral paths, statistically determined grids and search sequences to cover a given area under investigation. The method suggested here is merely a simple set of parallel traverses with readings obtained to cover the area by a square grid of readings.

If no other constraints dictate the direction of the principal traverses, they should be made in a north-south direction, for in any latitude there will be a greater peak-to-peak magnetic anomaly in this direction. As may be observed on the contour map of *Figure 43*, the maximum and minimum of an anomaly will be adjacent on such a line thereby creating a larger effective peak-to-peak anomaly and a maximum rate of change or slope, both of which enhance its detectability. In the case of long horizontal pipelines, traverses should be made perpendicular to the probable direction of the pipelines (except

for north-south pipelines at the magnetic equator where there is no anomaly over the mid-portions of the pipeline except for perhaps small permanent magnetization anomalies at pipe-section junctions).

The sensor should be held within several feet of the ground for small objects buried at shallow depths. There are occasions, however, when the sensor should be carried higher at perhaps 6 feet or more above the ground such as a situation where surface magnetic noise exists and where the anomaly depth is greater than perhaps 15 or 20 feet. In this case, the surface anomalies may be decreased by a factor of 20 or 30 while the anomaly of the object may only be decreased by a third greatly improving the visibility of the anomaly. If the situation allows, it is always recommended that a regular grid indeed be established and followed using local reference points, perhaps walking along a long string which is moved for each traverse, or possibly moving by a combination of dead reckoning and pacing, marking the lines already covered by pouring a visible powder such as lime or flour on the ground.

It is important to cover the area objectively and to know where one has already mapped and has yet to map. If a large area is to be covered, it is usually best not to be deterred from completing the measurements for an entire grid before returning to possible anomalies for more detailed measurements. It is indeed frustrating to those involved with the search not to 'follow-up' immediately any preliminary indications of an anomaly, but the net result is poor coverage of the grid, missed areas, lack of time to complete the grid, and disappointment in uncovering the wrong objectives. Where the area is large, the target of sufficient importance, and time of the essence, two or more magnetometers should be employed using one simply to pinpoint and follow-up each anomaly location and depth while the other continues to map the area under investigation.

#### Detailed Mapping for Pinpointing Location

After locating a given anomaly on a traverse, its location on the traverse should be so noted. As stated above, whatever the grid dimension, it is *likely that the object is not precisely under the original traverse, but rather to one side*. Therefore, the next traverse should be perpendicular to the original traverse at a point on the latter where the maximum horizontal rate-of-change (gradient) is observed. On this second or perpendicular traverse, the anomaly is usually of much greater amplitude and larger rate of change with distance indicating, of course, that one is closer to the object of search. A third traverse perpendicular to this second traverse and parallel to the original might be required if the exact location of the object is desired. Typical profiles, from a sequence of three such traverses are shown in *Figure 45* (the horizontal location cannot usually be determined to a precision greater than approximately 10% of the depth to the center of the dipole).

One then may wish to qualitatively compare the observed signature with those in *Figure 43* to determine the location in plan view of the object. Alternatively, one may use as a rule of thumb, the criterion that for locations in the magnetic 'polar or equatorial regions of the earth the object is probably located at the greatest maximum or minimum and for regions elsewhere the object is nearest the point on the anomaly where there is maximum horizontal gradient or rate-of-change. The variability of the orientation of the usually unknown perma-

nent moment and any very large or extended shape of the object may create complexity of anomaly shape in the 'near field' of an object. (NOTE: the magnetometer signal may also disappear which itself indicates a high gradient and therefore the near presence of an object.)

It may be important during this detailed mapping phase of a search to be able to recognize an anomaly of interest quickly so as to minimize the efforts involved in this localized remapping of what appears to be an anomaly of interest, but after the fact turns out to be something much too small, much too deep, or much too shallow had one been able to recognize certain anomaly characteristics. Approximate depth estimation is useful when also used, in turn, for estimation of the size of the object according to the order of magnitude methods described in the following. (See Chapter VIII for accurate depth determination using readings at two sensor positions.)

**Special Search Topics**

**Iron and Steel**

The maximum anomaly amplitude for a variety of objects can be estimated given their size, weight and description by using the formulae presented in **Chapters V and VI**. **For typical man-made iron or steel objects, the magnetic moment, M, is between 10<sup>5</sup> and 10<sup>6</sup> cgs units per ton (either 1000 kg or 2000 lbs.), where**

$$T = \frac{M}{r^3} \left( \text{for latitudes greater than } 60^\circ, \text{ use } T = \frac{2M}{r^3} \right) \text{ and}$$

T is the anomaly in gauss, M is the dipole moment in cgs and r the distance in centimeters. Thus the maximum anomaly for 0.1 ton of iron at a distance of 1000 centi-

meters would be between

$$T = \frac{10^5}{(10^3)^3} \times 0.1 = 10^{-5} \text{ gauss}$$

$$\text{and } T = \frac{10^6 \times 0.1}{(10^3)^3} = 10^{-4} \text{ gauss}$$

or 1 gamma < T < 10 gammas

This same formulae for a magnetic anomaly can be expressed directly in terms of gammas, pounds, and feet, if desired, for

$$1.75 \times 10^2 < M_{fps} < 1.75 \times 10^3$$

and

$$T = \frac{M_{fps}}{r^3}$$

where T is the anomaly in gammas, M the magnetic moment per pound of iron, and r the distance in feet between the object and the magnetometer. A ton of iron is therefore between 0.35 and 3.5 gammas at 100 feet or as a rule of thumb, can best be remembered as 1 ton of iron is 1 gamma at 100 feet. Figure 46 is drawn as a nomogram or guide in estimating anomaly amplitude for a dipole comprised of common iron or steel.

**Permanent vs. Induced Anomaly Sources**

In general, iron objects exhibit both permanent and induced magnetization which have a net magnetization producing a single magnetic anomaly in the earth's field as measured by the magnetometer. All rules herein

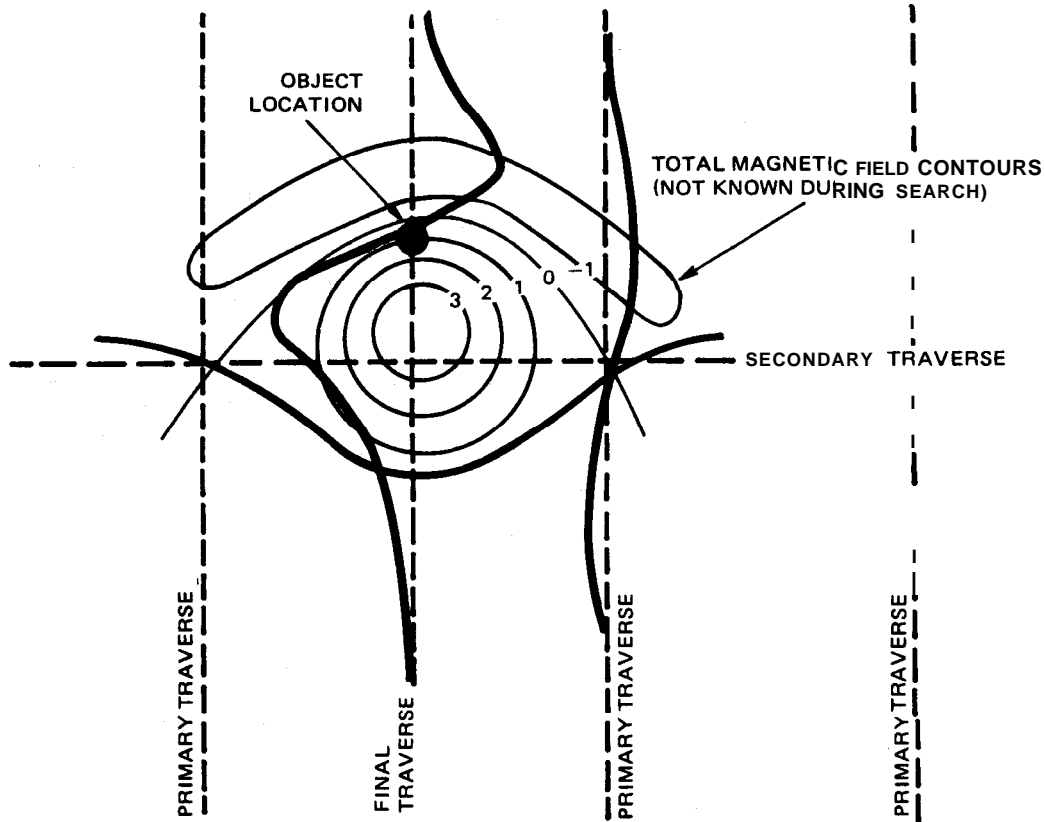
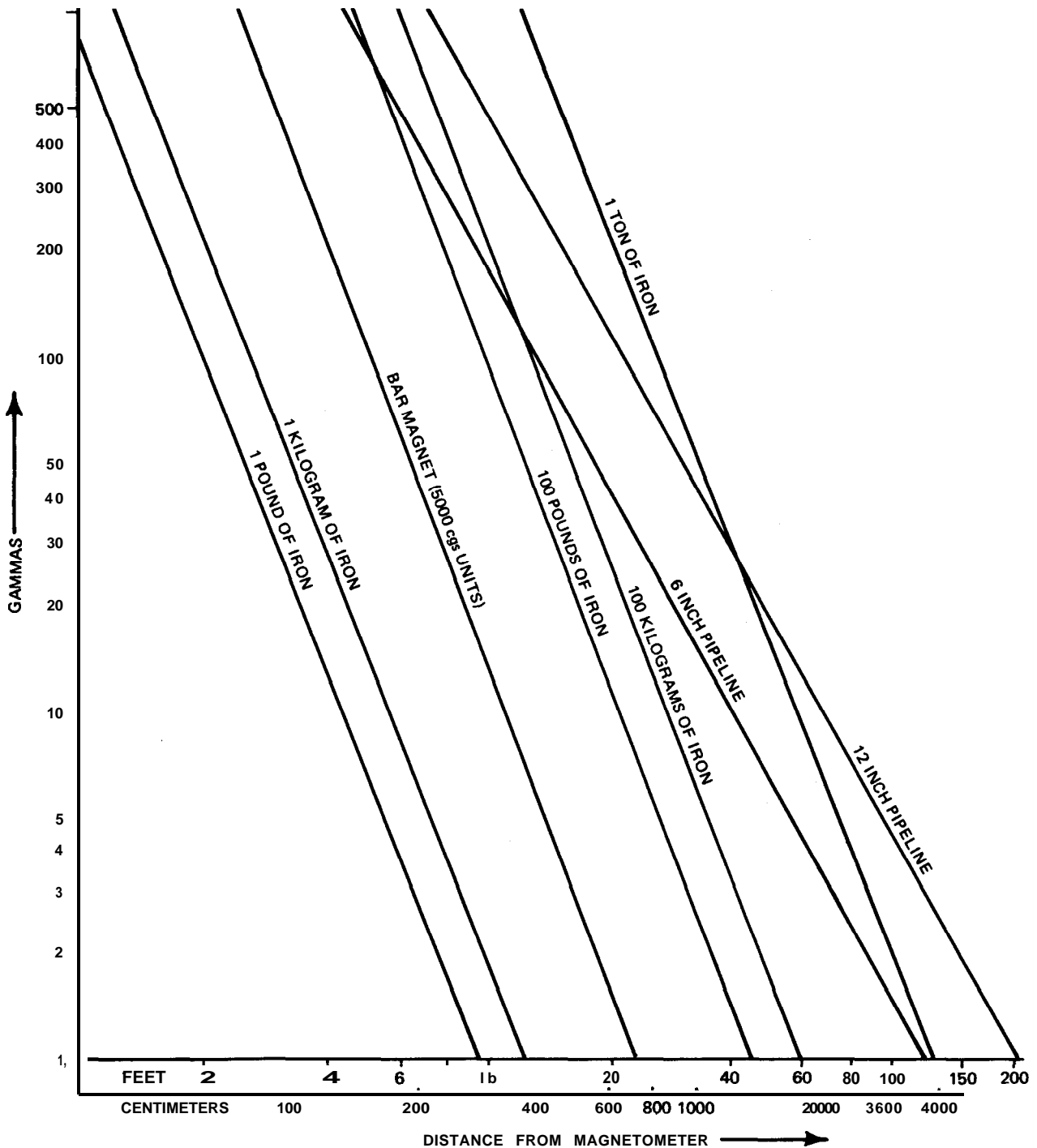

Figure 45. Typical Sequence of Traverses During Search Procedures (Profiles drawn on respective traverse lines)

Figure 46. Nomogram for Estimating Anomalies from Typical Objects (assuming dipole moment  $M = 5 \times 10^5$  cgs/ton, i.e.,  $k = 8$  cgs. Estimates valid only within order of magnitude)



#### INSTRUCTIONS FOR USE:

To use the nomogram, select a given weight or type of object from among the diagonal labeled lines. Then choose a distance along the bottom line (abscissa) of the graph and follow a vertical line upwards from that distance until it intersects the diagonal line of the selected object. At that point, move horizontally to the left to a value on the vertical axis (ordinate) of the graph and read the intensity in gammas.

At a given distance, the intensity is proportional to the weight of the object. Therefore, for an object whose weight is not precisely that of the labeled lines, simply multiply the intensity in gammas by the ratio of the desired weight to the labeled weight on the graph. If the distance desired does not appear on the graph, remember that for a typical object the intensity is inversely proportional to the cube of the distance and for a long pipeline the intensity is inversely proportional to the square of the distance between magnetometer sensor and object. Due to the many uncertainties described herein, the estimates derived from this nomogram may be larger or smaller by a factor of 2 to 5 or perhaps more.

assume for simplicity, that the anomaly is produced by the induced moment only. Nevertheless, the harder the steel, the more permanent magnetization it possesses, which at times may be 10 times or more than the induced magnetization. Although one cannot usually predict the orientation of the permanent moment of a buried object, it can be assumed that the larger the permanent magnetization, the larger the anomaly and the susceptibility,  $k$ , used in the formulae herein is really an effective  $k$  intended to include such increased magnetization. A single large part, such as a single pipe or an engine, etc., may exhibit one single anomaly due largely to the permanent moment. Conversely, the more component parts an object has, the more these individual permanent magnetic moments tend to cancel, leaving only the induced magnetization. When the permanent and induced moments are of the same order of magnitude (see revolvers, for example, in table of anomalies on page 46), and the permanent moment happens by chance to be oriented in an opposite direction to the earth's field, the observed anomaly would be very small, but almost never zero. Whether or not an object has a large or small permanent moment is not consequential except in explaining the unusual shape of the anomalies one might observe as compared to the anomaly signatures shown in *Figure 43*. (Note: Stainless steel, type 300, particularly Stainless 310, is practically non-magnetic. Similarly, manganese steel is only weakly magnetic.)

If one is able to measure the susceptibility, permeability or the magnetic moments by the procedures in Chapter VI, the following expression (also presented in Chapter VI) could be used to estimate the maximum anomaly amplitude

$$M = kFV$$

where  $M$  is the dipole magnetic moment in cgs units,  $k$  the susceptibility which is between 1 and 10 cgs units for most iron and steel objects,  $F$  the ambient field in gauss, and  $V$  the volume in cubic centimeters. If permeability,  $\mu$ , is to be used, recall that  $\mu = 1 + 4\pi k$ , numerically. Attention should be paid to the effects of demagnetization (Chapter VI under "Systematic Rotation for Magnitude and Direction") which describes the fact that an anomaly from a more-or-less spherical iron object may not be as large as predicted from consideration of  $\mu$  or  $k$  alone.

#### Pipelines (horizontal)

Most pipelines have very high permanent magnetization and show separate anomalies for each length of pipe, i.e., anomalies at each joint due to their independent thermal and mechanical histories. Valves and other attachments to pipelines show separate anomalies as well. A horizontal pipeline in steeply dipping fields or E-W at the equator varies inversely as the square of the distance between its center and the magnetometer and behaves as a line of dipoles as described in Chapter V. Thus, the maximum anomaly amplitude from a pipeline can be estimated as follows:

$$T = \frac{M}{r^2} = \frac{kFA}{r^2} = \frac{kF\pi Dt}{r^2}$$

where  $A$  is the approximate cross-sectional area of iron, and  $D$  and  $t$  are the pipe diameter and wall thickness respectively in the same dimensional units as the distance,  $r$ , and the other factors as used above. For most pipes, the steel is 'hard' and  $k$  (effective) is therefore high, perhaps, 10 to 50 cgs or higher. For example,

consider a horizontal pipeline diameter 6 inches, wall thickness 1/4 inch in a field of 50,000 gammas buried at a depth of 20 feet beneath the magnetometer,

$$T = \frac{10 \times 5 \times 10^4 \times \pi \times 6 \times \frac{1}{4}}{(20 \times 12)^2} = 40 \text{ gammas}$$

The expression,  $\pi Dt$ , represents the approximate cross sectional area of the thin wall of the pipe. A more precise but more complicated expression for this area might be  $(\pi R_o^2 - \pi R_i^2)$  where  $R_o$  and  $R_i$  are the outside and inside diameters of the pipe respectively.

For solid pipes, rods, or steel cable, a similar expression is used,

$$T = \frac{kFA}{r^2} = \frac{kF\pi R^2}{r^2}$$

where  $R$  is the radius of the rod.

The anomaly signature for pipelines in various directions and field inclinations would appear as in *Figure 47*. (Note the difficulties in detecting N-S pipelines in equatorial regions described above under "Traverses" and Chapter V.) The permanent magnetic moment is often predominant in a pipeline and may commonly exhibit a signature as shown in *Figure 47* with the maxima and minima reversed and a very large amplitude. A pipeline is generally easy to detect because its great length often assures one of actually crossing it. Also, the signature varies inversely as the square of the distance instead of the cube of the distance as in the case of a dipole (pipelines are lines of dipoles) and the anomaly amplitude thus remains large. If one has access to both ends of a hidden pipeline, it is also possible to pass a large DC current through it to aid in its detection by enhancing its magnetic field selectively in space or time. For example, to find one pipeline out of many possible interfering pipelines, pass a current through it for one reading and reverse the current for the next, taking two such readings at each point. The location of the one anomaly can be so mapped as the difference in these values becomes larger as one is closer to the pipe. (1 ampere of current through an infinitely long pipe would produce 10 gammas at 60 feet and would in this case produce 20 gammas peak-to-peak and vary inversely as the distance to the pipe. However, observe the geometry noted in Chapter IX.)

#### Magnetic Markers

It is often of interest to be able to relocate oneself or an object over a long period of time. The purpose may be to locate a survey benchmark, an important junction in a pipeline, or a point in shallow marine waters. In lieu of a radio transmitter or other active source, it is possible to bury a magnet which should keep most of its magnetic moment for many years or longer and at a depth sufficiently below any level that is likely to be disturbed. In some cases, it may be reasonable to bury several magnets oriented to produce maxima or minima or in a pattern to assure easy relocation or to differentiate one magnetic marker from another. Given a specialized requirement, a solenoid coil or single long wire with an applied direct current may also serve such a relocation purpose.

A magnet of convenient size and made of Alnico V is available in the form of a thumb-size 'cow-magnet', a

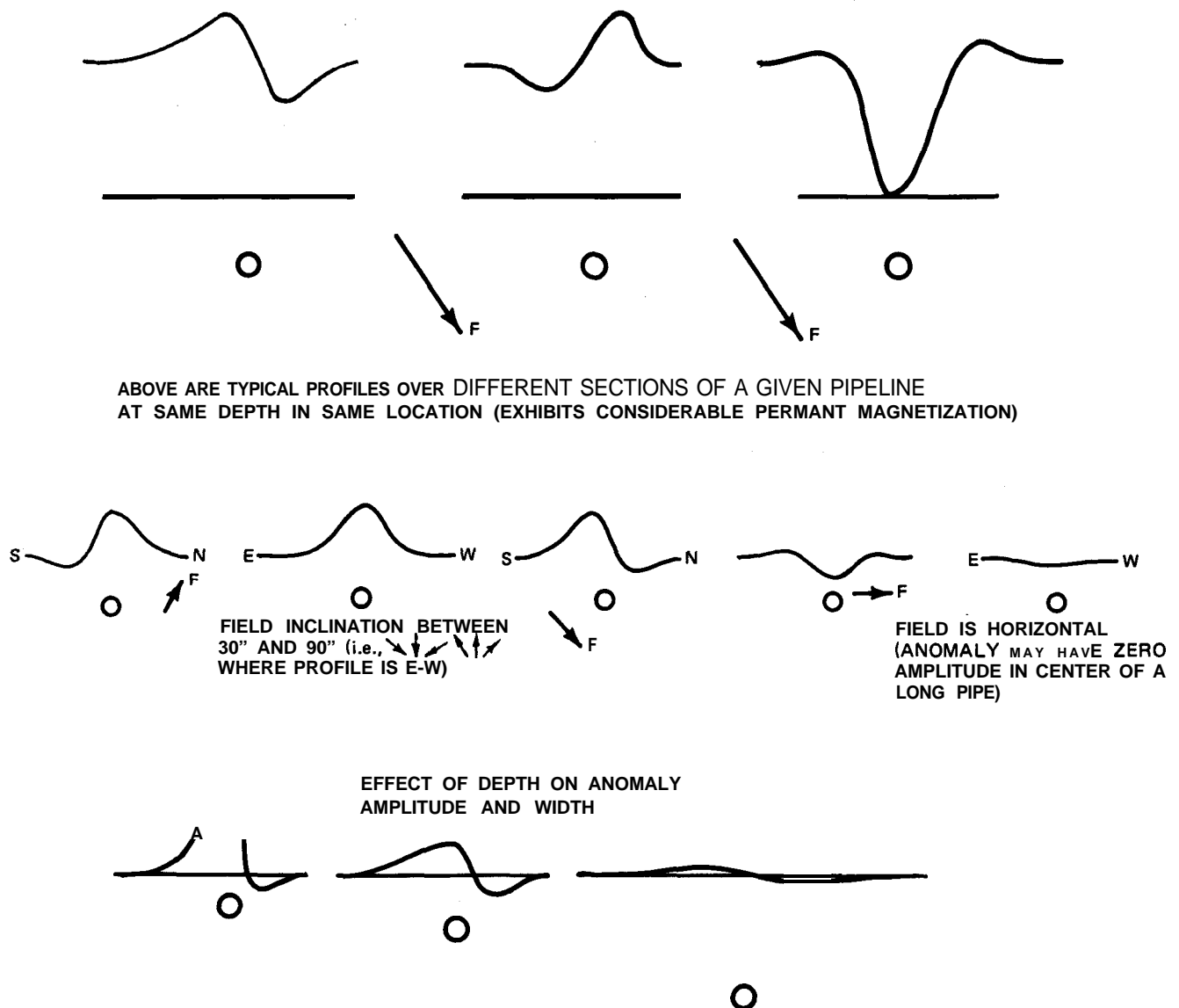

Figure 47. Pipeline Signatures

cylinder  $\frac{1}{2}$ " in diameter by  $2\frac{3}{4}$ " long, which will produce a magnetic moment of 5000 cgs units, or an anomaly of approximately 20 gammas at 10 feet. (Such magnets are available through the 'Farm' catalog of several large mail-order firms.) For comparison, a cylindrical Alnico V magnet 2" in diameter by 10" long will produce an anomaly of 1 gamma at 100 feet. Both anomalies will vary inversely as the cube of the distance and directly with the number of magnets laid end-to-end with opposing poles in contact with each other. Expressed in the terms above for calculating moments, such magnets would usually have an intensity of magnetization or magnetic moment per unit volume,  $I$ , of approximately 500 gauss per cubic centimeter.

The following table is illustrative of the magnitude of the anomalies which may be produced by several common objects. The values are merely typical and may easily be larger by a factor of 5 or smaller by a factor of 10 depending upon the actual size of the object, its metallurgy, orientation, permanent magnetization, number and relative size of component parts, position of the magnetometer relative to the object and to the field and other parameters discussed in Chapters V and VI.

## Archaeological Exploration

### Introduction

Magnetometers have been used for exploration at numerous archaeological sites around the world to detect such features as buried walls and structures, pottery, bricks, roof tiles, fire pits, buried pathways, tombs, buried entrances, monuments, inhabited sites, and numerous objects submerged in water such as ships, ballast stones, iron, cannon, amphora, various potsherds, etc. Most of these objects were detected and mapped as a result of their being more magnetic than the surrounding or covering material. A few features such as certain buried walls and tombs were not, themselves, magnetic, but displaced a uniformly magnetic soil which presently covers them. Still other sites both historical and archaeological have iron objects which are easily detectable according to the methods described in the preceding section.

### Magnetic Anomalies of Archaeological Origin

Anomalies exist at archaeological sites as a consequence of the contrast in magnetic properties between the cultural features of interest and the surrounding medium,

Table of Anomalies of Common Objects Typical Maximum Anomaly		
object	Near Distance	Far Distance
Automobile (1 ton)	30 feet 40 gammas	100 feet 1 gamma
Ship (1000 tons)	100 feet 300 to 700 gammas	1000 feet 0.3 to 0.7 gammas
Light Aircraft	20 feet 10 to 30 gammas	50 feet 0.5 to 2 gammas
File (10 inch)	5 feet 50 to 100 gammas	10 feet 5 to 10 gammas
Screwdriver (5 inch)	5 feet 5 to 10 gammas	10 feet 0.5 to 1 gamma
Revolver (38 special or 45 automatic) (induced approximately equal to permanent, see text)	5 feet 10 to 20 gammas	10 feet 1 to 2 gammas
Rifle	5 feet 10 to 50 gammas	10 feet 2 to 10 gammas
Ball Bearing (2mm)	3 inches 4 gammas	8 inches (0.5 feet) 0.5 gamma
Fenceline	10 feet 15 gammas	25 feet 1 to 2 gammas
Pipeline (12 inch diameter)	25 feet 50 to 200 gammas	50 feet 12 to 50 gammas
DC Train	500 feet 5 to 200 gammas	1000 feet 1 to 50 gammas
'Cow' magnet (½" W, 3" L)	10 feet 20 gammas	20 feet 2 gammas
Well casing and wellhead	50 feet 200 to 500 gammas	500 feet 2 to 5 gammas

*(Note anomalies are only representative and may vary by a factor of 5 or even 10 depending upon the many factors described herein.)*

both of which are usually composed of material of natural origin such as rocks or soil or even empty space. This magnetic contrast is a function of the concentration and thermal and mechanical history of magnetite present in either the cultural feature or its burying medium. The amount of magnetite determines the magnetic susceptibility and therefore the induced magnetization as described in Chapter III for various configurations and for a variety of natural materials. Remanent magnetization, commonly present in materials which have undergone heating, is responsible for the most prominent anomalies arising from cultural features (with the exception of iron).

### Remanent Magnetization

The remanent magnetization of archaeological objects is particularly significant not only because of its large relative intensity, but because it is intimately associated with many enduring objects of ancient habitation, namely, baked clay which comprises bricks, tiles, pottery, kilns, hearths and similar features. This remanent magnetization otherwise called thermoremanent magnetization (see Chapter III) is created when the magnetite-bearing clay is heated to a relatively high temperature and cooled in the presence of the earth's magnetic field. Magnetic domains within each magnetite crystal are at first randomly oriented then move about during heating. Upon cooling, many domains align themselves with the ambient or earth's field and thus parallel to each other creating a net magnetization fixed with respect to the

object and parallel to the earth's total field at the time of cooling.

### Archaeomagnetism

Such objects are not only easier to find than most other objects at archaeological sites, but in certain cases, where their kiln-baked position with respect to the vertical is known, they can also be used to estimate the age of the object. The age can be determined by measuring the inclination of the remanent magnetization (by methods described in Chapter VI) which occurred at the time it was baked. This magnetic inclination can then be compared with the history of the variation of the earth's magnetic inclination known through historical records and other fire-baked clay objects already dated by other methods.

### Magnetization and Susceptibility of Soils

Soils exhibit a magnetic susceptibility related in general to the susceptibility of the rocks from which they were derived, i.e., soils from volcanic or other igneous rocks have a higher susceptibility than soils weathered from sandstone, limestone or shale. However, magnetite being among the most resistant minerals appears to be present in the soils in higher proportion than other, more soluble minerals. In addition, organic action particularly in humus soils, is thought to be responsible for the formation of the magnetic mineral, maghemite, from other non-magnetic forms of iron oxide—a phenomenon of importance in mapping features associated with

tion. Therefore, soils may have a somewhat higher susceptibility than would be indicated by the parent rock susceptibility, soils of  $10^{-4}$  cgs being common. This surface magnetite is also a source of magnetic noise in precision magnetic surveys performed very close to the surface of the ground when the magnetite, by the action of surface waters and gravity, collects into small pockets of placer magnetite common almost everywhere in the microtopography of the ground surface.

#### Remanent Magnetization of Soils

Of additional significance to archaeological exploration is the presence in surface soils of remanent magnetization often with twice the intensity of induced magnetization. This magnetization is due sometimes to heating, but more probably to 'viscous' magnetization attained slowly in place (during tens to thousands of years) and the formation in situ of maghemite by the organic processes cited above. This remanent magnetization is most common in the upper layers of soil and if disturbed by cultivating, by digging graves, by foot or animal traffic, or by other physical disruption of the integrity of the soil, is destroyed creating a locally negative anomaly, often mappable with a portable magnetometer.

#### Magnetic Anomaly Complexity

The anomalies observed at archaeological sites are in most cases very complex as a consequence of several factors. The sources which produce the anomalies are relatively shallow and therefore close to the magnetometer which emphasizes the extremely complex nature of the 'near field' of any magnetic object. Also, the various sources of magnetic anomalies from soils, near surface rocks and the clutter of ancient or modern human habitation, including the very objects of interest, is often very pronounced. The nature of the measurements one obtains in archaeological exploration-closely spaced and near to the ground surface-makes the data seem more noisy than they appear on the usual mineral exploration survey. An archaeological survey properly conducted, planned and interpreted, however, can often make sense of this complexity and produce meaningful interpretations from individually resolvable, magnetic archaeological features.

#### Archaeological Survey Planning and Feasibility

Successful application of a magnetometer to archaeological prospecting can assist an archaeological program in several ways. Most obviously, the specific site and features which are hidden from view can be located, depths estimated and excavations conducted efficiently, rapidly and more economically than if the locations were not known with any confidence. In some instances, excavations need not be performed at least initially, where boundaries of structures and the extent of the site can be mapped through magnetic surveys, e.g., salvage archaeology, extending known sites, etc.

Although it may be tempting to assume that a magnetic survey may be useful in mapping and detecting features at a given site, *it may be fair to state that most sites a priori, are not amenable to this method* Features may not present a detectable magnetic contrast, the magnetic background noise may be excessive or the site may be better mapped through less sophisticated means such as visually or other tried and true techniques.

The known features should first be considered or measured by the techniques outlined in Chapter VI to deter-

mine if there is, in fact, a measureable magnetization contrast (estimated by methods of Chapter V). Representative samples of both the buried features as well as the burying material should be measured with special attention to such items as: fist-size samples of structures, fire-baked large objects, soil, soil intact (to preserve remanent magnetization), humus-rich material, cultural material present in appreciable amounts, rocks which are thought to underlie the site (which may create insurmountable noise as from volcanic rocks or laterite) and other material which may be present in any significant way at the site.

Having measured the induced and remanent magnetization (not important to measure the directions), having estimated the amplitude of the anomalies and having determined the background magnetic noise, one may be able to predict whether a magnetic survey would be of significance. *One can never really be certain of its feasibility, to be sure, until a survey is attempted.*

The depth and amplitude can then be used as criteria to determine the grid, or density of individual measurements. Commonly, the area is divided into manageable quadrangles perhaps one or two hundred feet on a side and a rope, marked by colors, alternating at the grid points, is laid along one traverse line (or perhaps a rope grid is constructed). Measurements are taken at each point on the rope and the rope moved away one grid distance away from its first position, etc. Sometimes careful pacing between known grid points at the edge of the quadrangle is sufficient for the measurements. A spring-wound reel fixed to the ground at one side of the quadrangle with a distance-marked cord attached to the magnetometer-bearer is a very rapid means for measuring distance. Care should be taken to make sure a magnetic heading error does not occur when the operator faces the other direction upon returning on alternating traverses. The measured or empirically-determined offset, however, can be applied to correct for such an offset. Time variations may be removed, if small or deep anomalies are sought, by methods in Chapter IV using either a recording base station, tie lines (two or more lines which cross the traverse lines), or re-occupied stations.

The data should then be contoured (see Chapter IV) and interpreted in light of what is known about the site. After and during excavations, it may be useful to follow up the survey by mapping select areas once again after some sources are removed and if the depth to features of interest is thus markedly decreased (by access to deep and wide holes and if the soil is not too magnetic or magnetically disturbed).

#### Archaeological Anomaly Amplitude and Signatures

In order to estimate the maximum anomaly from an archaeological object, consider the anomaly from a single cube of rock representing perhaps a buried monument.

$$T = \frac{kF D^3}{r^3}$$

where T = the anomaly in gammas, k the susceptibility contrast per unit volume, F the earth's field intensity in gammas, D the dimension of one side of the cube in the same units as r the distance between the magnetometer and center of the cube of rock in any distance

units whatever. As an example, consider a monument of volcanic rock,  $k = 10^{-2}$  in a soil of  $k = 10^{-4}$ , in a field of 50,000 gammas formed of a cube 2 feet on a side at a distance of 5 feet. The  $k = 10^{-4}$  is so small as to be negligible in comparison with  $10^{-2}$  and the susceptibility contrast is therefore  $10^{-2}$ . Thus

$$T = 10^{-2} \times 5 \times 10^4 \times \left(\frac{2}{5}\right)^3 = 32 \text{ gammas}$$

On the other hand, a void or tomb of the same geometry and in the same soil would have a negative anomaly of

$$T = -10^{-4} \times 5 \times 10^4 \times \left(\frac{2}{5}\right)^3 = -0.32 \text{ gammas}$$

Note that the amplitude for the void is negative for it is opposite to what one would expect for a magnetized material since the void is simply the absence of material.

Generally speaking, a void cannot easily be detected when the distance between the magnetometer sensor and the center of the void is much greater than the diameter of the void. This arises from the fact that in order to detect the void, the soil or rock must itself have an appreciable magnetization, the higher the contrast, the larger the anomaly. Large magnetizations, however, are intimately associated with non-uniform or inhomogeneous magnetization which is a significant source of magnetic noise obscuring the subtle anomaly signature of the void at the empirically-determined limit noted above.

Other anomalies can be computed by the methods presented in Chapter V and the susceptibilities of Chapter III. Figure 48 portrays several types of anomaly signatures at different latitudes for various possible situations of archaeological features.

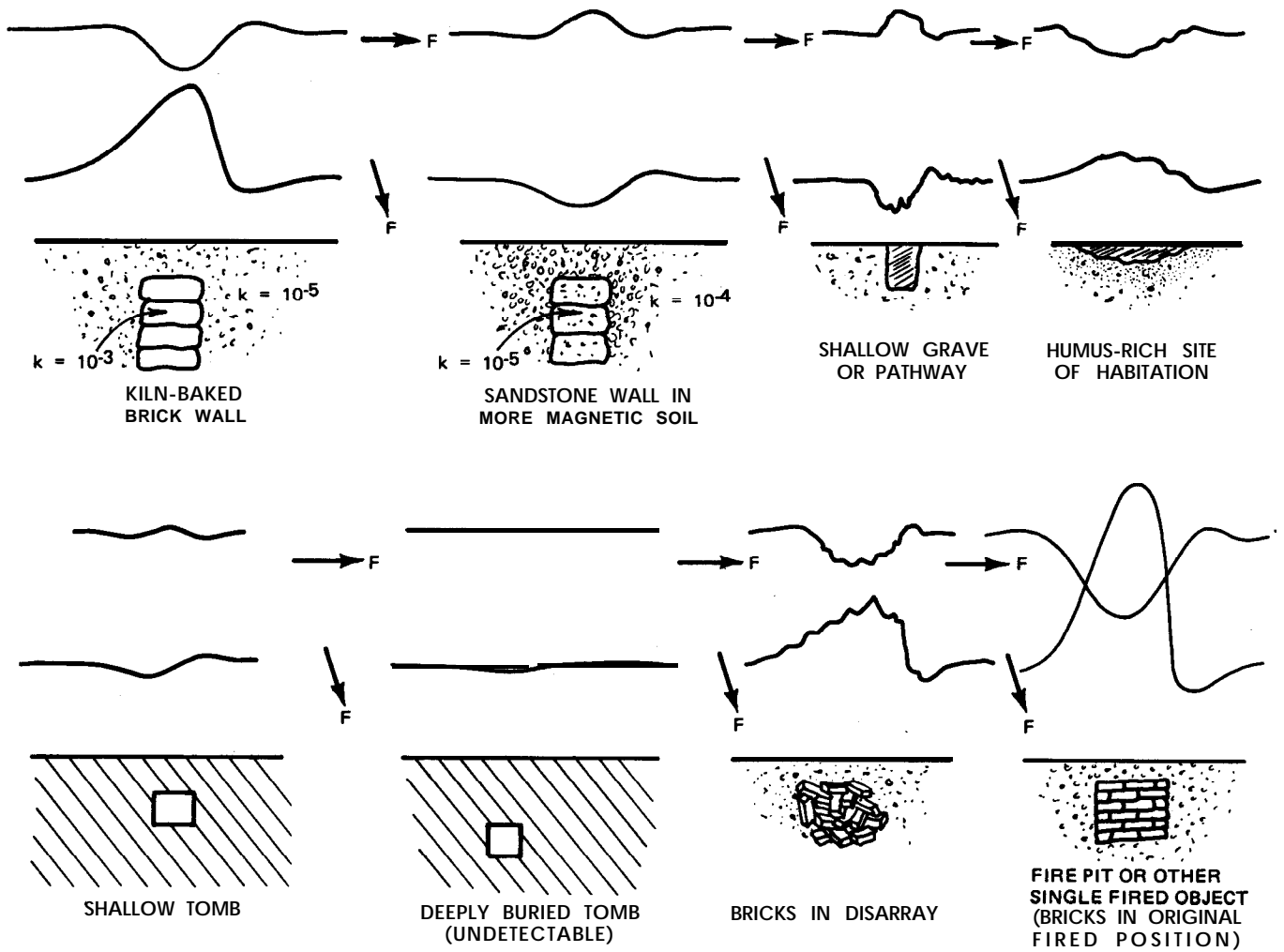

Figure 48. Typical Magnetic Anomalies of Common Archaeological Features



## VIII.

# GRADIOMETERS AND GRADIENT TECHNIQUES

### Introduction

It is of some interest in exploration to measure various gradients, particularly the vertical gradient using a portable magnetometer. The average horizontal gradient along the traverse can easily be computed from the profile, whereas the vertical gradient from typical, widely-spaced ground traverses cannot be accurately computed. A gradiometer is so named because it measures the gradient and in the context of the Manual, the gradient of the total field. In order to meet all the requirements and applications suggested in this chapter, the *gradiometer* is here defined as a differential magnetometer where the spacing between sensors is fixed and small with respect to the distance to sources whose gradients are to be measured. The difference in intensity divided by the distance between sensors is then the gradient measured at the midpoint of the sensor spacing. A quasi-differential magnetometer using a single instrument with successive measurements with the sensor at two or more positions is suggested as more practical for most uses than a two sensor configuration.

Generally, it is more desirable for gradient measurements to have higher sensitivity on the order perhaps of 0.25 gammas for reasons that will become obvious, but 1 gamma sensitivity is adequate when the anomalies and their gradients are relatively large. As an additional condition, it is relatively important in any ground gradient applications that there be no significant surface magnetic noise, for gradient anomalies tend to greatly enhance such shallow noise sources which would be detrimental for most objectives.

### Applications of the Gradiometer

The vertical gradient or any gradient for that matter has several properties of interest in exploration. First, gradient anomalies tend to resolve composite or complex anomalies into their individual constituents and on the same basis automatically remove the regional magnetic gradient to better define the shallower anomalies assumed to be of interest. Also, the magnetic time variations including the effects of magnetic storms are effectively removed. The measurements which comprise the gradient are made almost simultaneously and very closely spaced compared to the source of magnetic storm effects and diurnal variations so that such effects on the two readings are essentially identical and therefore removed on the differential. A third useful attribute of the gradients is that they can be used very quantitatively or for their vector properties (gradient of the scalar) in ascertaining anomaly depth, magnetic moment, shape, and location. These vector properties also allow use of the vector diagram techniques formerly requiring the more cumbersome horizontal and vertical component magnetometers or modified dip needles.

Use of a portable magnetometer as a gradiometer also involves several difficulties over use of the instrument as a simple single-reading magnetometer. Some of the

applications require not just two but three or even four separate readings per station and the attendant additional data reduction efforts. The usual advantages of an orientation-insensitive scalar instrument represented by a proton magnetometer are partially defeated in the directional requirements inherent in the two readings of a gradiometer, albeit they are only on the order of  $\pm$  several degrees. Lastly, considerably more care must be taken in obtaining the data (e.g., magnetic cleanliness of operator, positioning of sensors, etc.) for a gradiometer implies and utilizes higher resolution total intensity measurements. The proper application of the gradiometer techniques outlined in this Chapter, however, may easily justify such extra effort for many geological, search and other objectives.

### Conditions for Gradient Measurement

As defined above, a gradiometer is first a differential magnetometer, i.e., a difference,  $\Delta T$ , is measured or computed between two readings at different locations. For many if not most applications, the conventional total field at one of the positions (in practice, either one) is also utilized. The word *fixed* is in the definition to denote the difference between a gradiometer as used here, and a differential magnetometer where one sensor is fixed, the other traversing, connected so as to remove time variations.

The most significant requirement expressed in the definition is that which requires that the spacing between sensors, i.e., their positions of measurement,  $\Delta r$ , be small with respect to the distance,  $r$ , to the sources of the anomalies under investigation. If one considers a dipole, for example, one sensor at  $r$  would measure an anomaly  $T$ . A second sensor at  $2r$  would only measure  $\frac{1}{8}$  of  $T$ , i.e., the second sensor is essentially not sensing the anomaly at all and may as well be at infinity. The differential measurement in this case is, for all practical purposes, the same as the usual single sensor total field measurement. More specifically, the gradient can be expressed as

$$\frac{\Delta T}{\Delta r} \approx \lim_{\Delta r \rightarrow 0} \frac{T_r - T_{r+\Delta r}}{\Delta r} = \frac{dT}{dr}$$

where  $\Delta T = T_r - T_{r+\Delta r}$  is the total field differential between two sensor positions spaced  $\Delta r$  apart and  $\frac{dT}{dr}$  is the deriva-

tive or gradient of  $T$  in the direction of  $r$ . The expression,  $\Delta r \rightarrow 0$  expresses the mathematical condition that  $\Delta r$  should be small with respect to  $r$  (in theory  $\Delta r$  should be zero). If  $\Delta r$  is less than  $\frac{1}{10} r$  or even  $\frac{1}{5} r$ , the condition is well satisfied in the context of all suggested applications. Usually there is no point in making  $\Delta r$  smaller than  $\frac{1}{10} r$ , for the gradiometer sensitivity (as expressed in the following) will be unjustifiably degraded. Practical considerations as well limit both maximum and minimum  $\Delta r$ .

(Note: as explained in Chapter II, a total field magnetometer measures only the vector component of any local anomaly in the undisturbed direction of the field. For a local anomaly  $T$ , then, the magnetometer will measure the component,  $T_F$ , in the direction of  $F$  as previously presented. The gradiometer will then effectively measure  $\frac{dT_F}{dr}$ , i.e., the gradient in the direction  $r$  of the component in the total field direction of the anomaly  $T$ .)

### Gradiometer Sensitivity

The expression  $\frac{\Delta T}{\Delta r}$  or  $\frac{dT}{dr}$  is the measurement observed with the gradiometer (after proper data reduction). The gradiometer thus measures a gradient expressed in gammas per foot or gammas per meter, etc. in the direction of  $r$  (or the vertical gradient,  $\frac{dT}{dz}$ , in the direction of  $z$ ) which may be contrasted with the basic magnetometer measurement of  $T$  (actually total field,  $F$ ), which is a scalar and inherently specifies no direction. (NOTE: the total field anomaly  $T$  is used herein instead of total field  $F$  to simplify and be more consistent in the expressions for the anomalies themselves).

The smaller the value of  $\frac{\Delta T}{\Delta r}$  that the gradiometer can measure, the more sensitive is the gradiometer. This value can, in turn, be made smaller by minimizing  $\Delta T$  or maximizing  $\Delta r$ . Thus, for a magnetometer with a sensitivity of 1 gamma and spacing of 3 feet between sensor positions, the gradient sensitivity would be  $\frac{1}{3} = 0.3$  gamma per foot. For a magnetometer with 0.25 gamma sensitivity and sensor spacing of 3 feet, the gradient sensitivity is  $\frac{0.25}{3} = 0.08$  gamma per foot.

Increasing the sensor spacing to 8 feet and using 0.25 gamma magnetometer sensitivity provides  $\frac{0.25}{8} = 0.03$  gamma per foot sensitivity—adequate for many petroleum exploration applications.

### Gradiometer Readings in the Field

The gradiometer measurements incorporated in some of these applications are the vertical gradient  $\frac{dT}{dz}$  and the two horizontal gradients,  $\frac{dT}{dx}$  and  $\frac{dT}{dy}$ ,  $z$  being the vertical coordinate,  $x$  along the profile and  $y$  normal to the profile. When these three gradients are used together, the symbolism for partial derivatives,  $\frac{\partial T}{\partial x}$ ,  $\frac{\partial T}{\partial y}$  and  $\frac{\partial T}{\partial z}$  will be used, but they are the same numerically as their corresponding expressions above.

A vertical differential reading can be obtained by using a single magnetometer with the sensor placed first at one elevation and then another over the same point on the traverse. Typical elevations are 4 feet and 8 feet for very large gradients (mineral exploration or search) or 4 feet and 12 feet for smaller gradients, the larger the separation the more sensitive the gradiometer. It is important in the vertical gradiometer observations that the sensor occupy the same horizontal position when

making each measurement. One possible arrangement is to place the sensor on a long staff and to place an additional support or staff, at right angles to the principal staff near the sensor. Thus, readings could then be taken on each of these staffs so long as adequate signals are obtained for these orientations. (See *Figure 49*.)

Horizontal gradients can be computed from the total field data as the slope of the total field profile at any point of interest which is one example of the necessity for total field, not simply vertical gradient alone. Adequate horizontal gradients can only be computed in this manner when the anomalies are extremely broad, i.e., the sources deep, relative to the station density, as might be true for many petroleum surveys. In the case of shallow anomaly sources as in mineral exploration where the total field variations and their gradients are large and rapidly changing, the individual total field measurements may be spaced too far apart to allow for accurate slope measurements at the points where the vertical gradient is observed. In such surveys, the horizontal gradient can be measured in any of several ways with increasing accuracy, but also increasing time and effort.

In theory, a gradiometer measures the gradient at the midpoint of the sensor spacing. Ideally therefore, one may wish to measure the vertical gradient with two measurements above and below a point  $P$  and the horizontal gradient (or gradients) from two additional measurements in front and back of the same point for a total of 4 measurements. A purist may also recommend that where total field is required, it, too, should be measured at  $P$  as a fifth measurement and if the other horizontal gradient is desired as well, it would involve 2 additional observations for a grand total of 7 readings.

In practice, however, particularly for sources deeper than, say, 100 feet, what is recommended is simply three readings, two spaced perhaps 8 feet apart at the higher elevation of 12 feet, and one beneath either of the first two at an elevation of 4 feet. The assumption would be made that all measurements were centered about the same point (see *Figure 49*), as the ideal case above.

The lower reading of any vertical gradiometer pair of measurements should seldom be made much closer than several feet to the ground surface due to possible effects of surface noise from the microtopography, placer magnetite, etc. On the other hand, it is desirable to maximize the separation between sensors to increase the sensitivity of the gradiometer without making the higher sensor unwieldy and impractically high. The two sensors in any configuration should not in general be off a vertical or horizontal line by more than 5 or 10 degrees if at all possible, for one is making a vector dependent) measurement.

### Gradiometer as a Filter

For reasons detailed in the following section below, the gradiometer automatically removes the regional gradient, and increases the resolution of even local anomalies (see *Figure 50*). Each anomaly is portrayed as a more resolved anomaly, separating, for example, the anomaly from different edges of a source into two or more discrete anomalies (see *Figure 57*). This increased resolving power is exhibited by horizontal or vertical gradiometers equally well. The same property, however, precludes useful application of a gradiometer in areas of surface noise, i.e., very local anomaly sources.

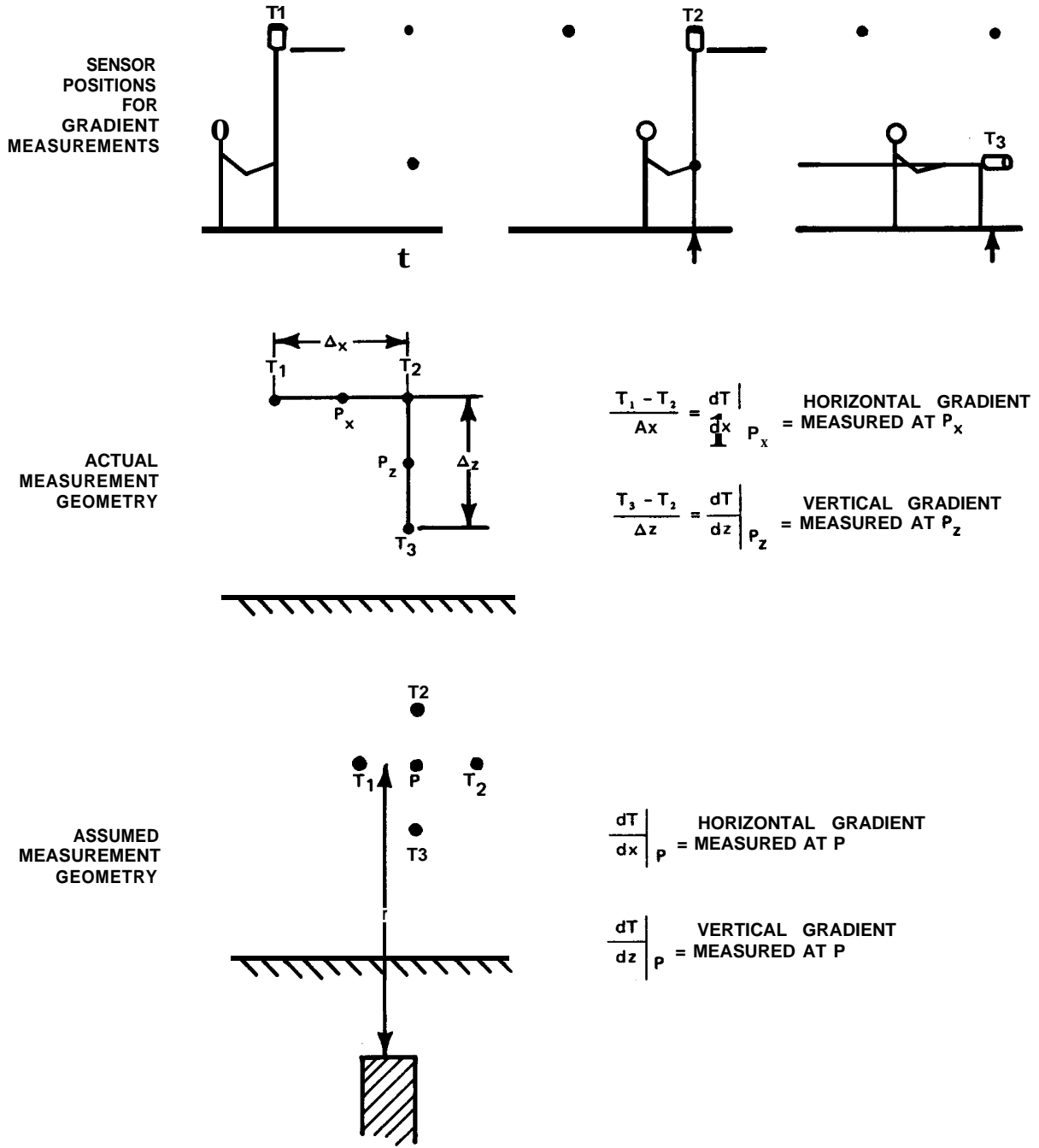

Figure 49. Gradiometer Measurement Procedures

**Calculation of Vertical Gradient**

For a dipole, the vertical gradient is expressed by taking the derivative of the simplified expression of the dipole (see Chapter V for other orientations of a dipole):

$$T = \frac{M}{z^3}$$

and

$$\frac{dT}{dz} = \frac{-3M}{z^4} = \frac{-3}{z} \frac{M}{z^3} = \frac{-3T}{z}$$

Note that the gradiometer anomaly from a dipole varies as  $\frac{1}{z^4}$  which explains why the gradiometer automatically

removes non-local anomalies, such as the regional gradient. In other words, the gradient varies much more with distance than the total field, or expressed in other terms the difference in intensity between two nearby sensors from distant sources is so small that it is negligible compared to the difference in intensity from nearby sources.

The above expression,  $\frac{3T}{z}$ , is a convenient form for

rapidly estimating the gradient from a dipole given only the total field anomaly and the distance to the source. For example, the earth's field itself thus has a vertical gradient of 0.004 and 0.008 gammas per foot at the equator and at the poles respectively.

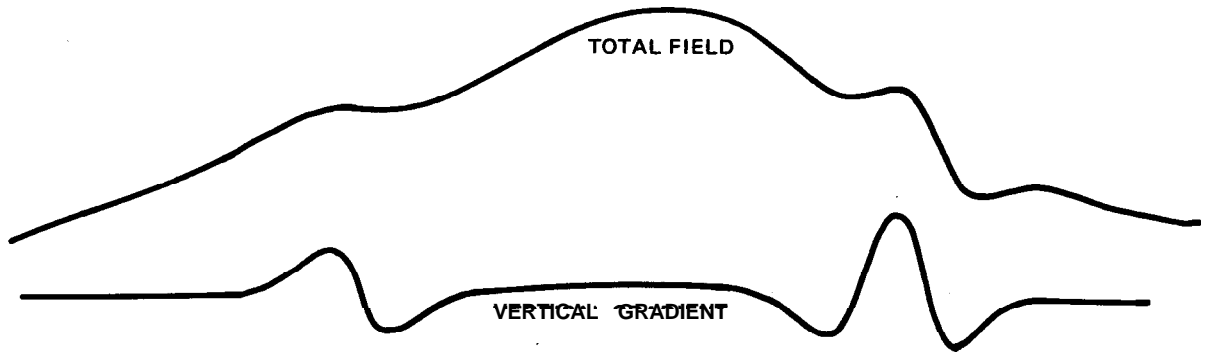

Figure 50. Gradiometer as a Filter for Removal of Regional Gradient

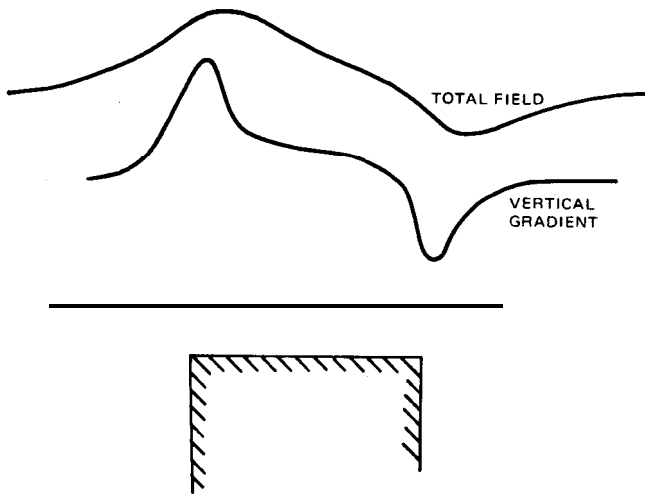

Figure 51. Gradiometer for Resolving Local Anomalies

For a monopolar source,

$$T = \frac{M}{z^2}$$

and

$$\frac{dT}{dz} = \frac{-2M}{z^3} = \frac{-2}{z} \frac{M}{z^2} = \frac{-2T}{z}$$

The gradiometer anomaly from a monopole source is seen to vary as  $\frac{1}{z^3}$ . In fact, for any generalized source which has a total field expression,

$$T = \frac{M}{r^n}$$

the gradiometer anomaly is

$$\frac{dT}{dr} = \frac{-nM}{r^{n+1}}$$

and any gradiometer anomaly therefore varies at a higher rate or fall-off than its corresponding total field anomaly.

### Depth Estimates from Vertical Gradients

If one assumes that a given source is a dipole as would be true for most objects of search and thus has a fall-off factor  $n = 3$  (see above), then by measuring the gradient,  $\frac{dT}{dz}$ , and the total field anomaly,  $T$ , over the anomaly, one can determine the depth  $z$ , for

$$z = \frac{-3T}{\frac{dT}{dz}}$$

Thus, it is possible in this case to determine the depth without requiring knowledge of the magnetic moment or of what it is comprised other than that it behaves as a dipole. Furthermore, these values can then be re-inserted in the basic expression for the dipole to compute  $M$  which is the product of  $k$ ,  $F$ , and  $V$  which, in turn, may be helpful in determining the susceptibility or volume for ore reserves, rock type, etc.

Whether or not, the dipole anomaly involves  $M$  or  $2M$  for the magnetic moment is not important, for if

$$T = \frac{2M}{z^3},$$

then

$$\frac{dT}{dz} = \frac{-6M}{z^4} = \frac{-3T}{z}$$

and

$$z = \frac{-3T}{\frac{dT}{dz}}$$

which is the same as given above for  $T = \frac{M}{z^3}$ . Therefore,

the depth may still be calculated, for, as stated, this method removes the dependence on the knowledge of the magnetic moment  $M$  and its factors.

For a monopole,

$$z = \frac{-2T}{\frac{dT}{dz}}$$

and for a horizontal cylinder,

$$z = \frac{-2T}{\frac{dT}{dz}}$$

for the edge of a narrow vertical dike,

$$z = \frac{-T}{\frac{dT}{dz}}$$

and for any generalized anomaly,

$$z = \frac{-nT}{\frac{dT}{dz}}$$

(Note: Refer to Chapter V for a summary of 'n', the fall-off factor.)

Alternatively, one may wish to calculate depths by using the two total field measurements separately instead of their use in the gradient calculation particularly when the sensor spacing is greater than 1/5 of the distance to the source which invalidates the gradient measurement. As an example, consider again the dipole

$$T_z = \frac{M}{z^3} \text{ at elevation } z$$

and  $T_{z+\Delta z} = \frac{M}{(z+\Delta z)^3} \text{ at elevation } z+\Delta z.$

Then, by dividing the two expressions,

$$\frac{T_z}{T_{z+\Delta z}} = \left(\frac{z+\Delta z}{z}\right)^3$$

and

$$z = \frac{Az}{\left(\frac{T_z}{T_{z+\Delta z}}\right)^{1/3} - 1}$$

**General Expression Involving Gradients and Coordinates**

The above expressions for depth estimates involving the vertical gradient and z are merely a special case of the following general expression (known as Euler's expression for homogeneous equations):

$$x \frac{\partial T}{\partial x} + y \frac{\partial T}{\partial y} + z \frac{\partial T}{\partial z} = n T$$

where n is the fall-off factor (e.g., n = 3 for a dipole, n = 2 for a monopole, etc., see Chapter V). Thus, over the anomaly where x = 0 and y = 0,  $z = \frac{-nT}{\frac{\partial T}{\partial z}}$ , as above.

Such an expression is only applicable for simplified sources having a single effective value of n (i.e., mathematically homogeneous to degree n). It is possible to utilize the measured values of the gradient at various points on a profile to solve for the depth, z (and the fall-off factor, n). Assuming that the profile is, for example, over the anomaly source and in a magnetic north direction (x-direction),  $\frac{\partial T}{\partial x}$  and  $\frac{\partial T}{\partial y}$  would be small and the term,  $y \frac{\partial T}{\partial y} \approx 0$ . Where the horizontal gradient(s) is zero,

$$\frac{\partial T}{\partial x} = 0 \text{ and } z = \frac{-nT}{\frac{\partial T}{\partial z}}, \text{ similarly where } x = 0, \text{ again } z = \frac{-nT}{\frac{\partial T}{\partial z}}$$

Thus, z and n have the same relative value or ratio at these two points on the profile, one noted by observation

of the  $\frac{\partial T}{\partial x} = 0$  which would be at a peak (maximum or minimum) of the anomaly and the other at x = 0, i.e., the point immediately over the anomaly source. Thus, the point x = 0 can be determined. Plotting values of z as a function of n for various values of  $\frac{\partial T}{\partial x}, \frac{\partial T}{\partial z}$  and x will thus produce a series of straight lines intersecting at the solution of z and n as shown in Figure 52.

An expression similar to Euler's equation can be derived which does not involve the magnitude of the anomaly itself, but only the gradient and can be used for solving for anomaly location and depth. The algebraic scalar (or dot) product of the radius vector,  $\vec{r}$ , and the gradient vector,  $\vec{\nabla}T$ , taken at any point along the profile is

$$x \frac{\partial r}{\partial x} + y \frac{\partial r}{\partial y} + z \frac{\partial r}{\partial z} = |\vec{\nabla}T| |\vec{r}| \cos \theta$$

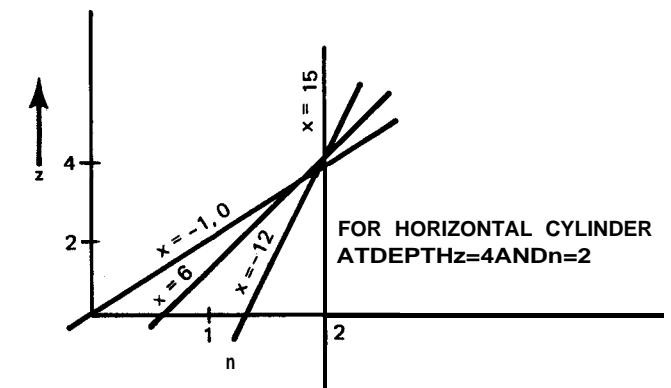
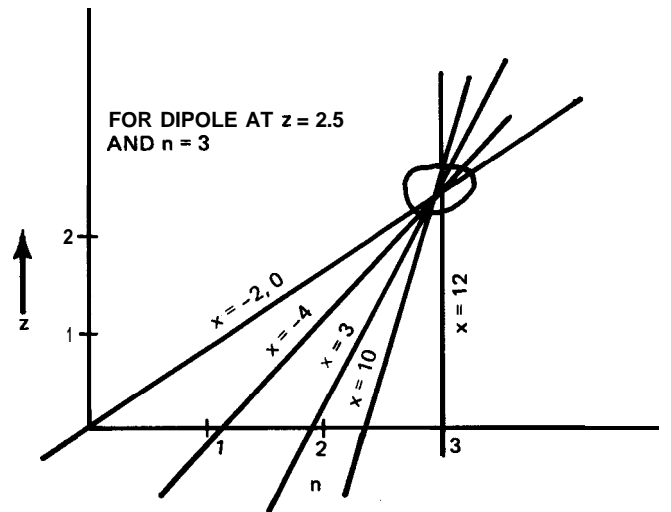

Figure 52. Graphical Solution to Euler's Equation for Depth and Fall-off Rate for Typical Case

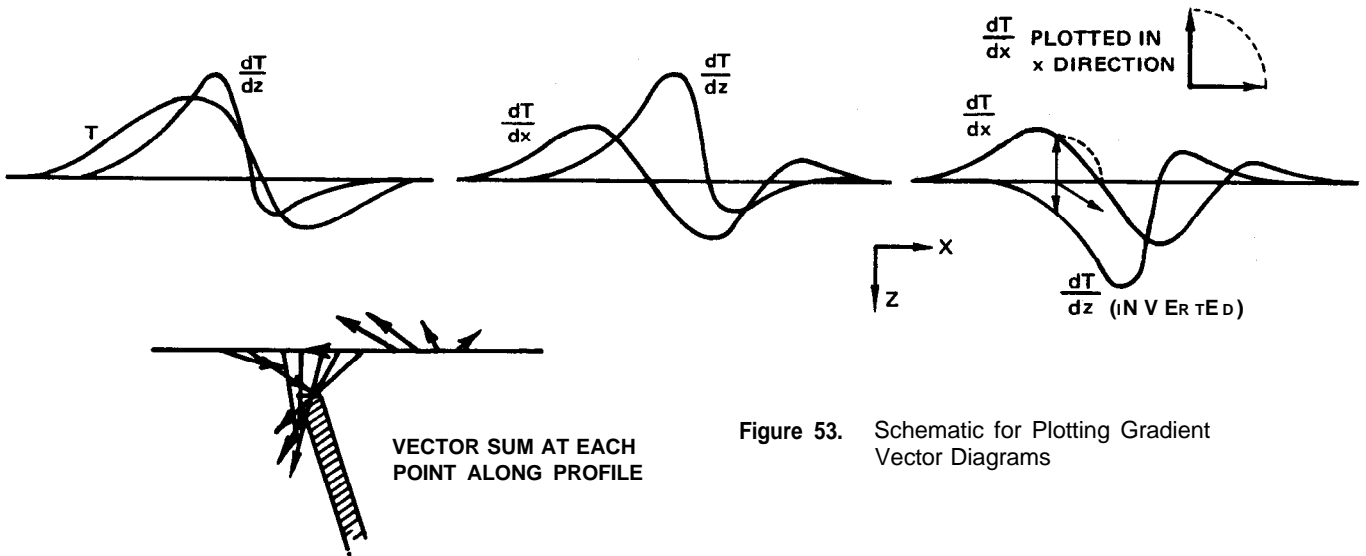

Figure 53. Schematic for Plotting Gradient Vector Diagrams

where

$$|\nabla T| = \left[ \left( \frac{\partial T}{\partial x} \right)^2 + \left( \frac{\partial T}{\partial y} \right)^2 + \left( \frac{\partial T}{\partial z} \right)^2 \right]^{1/2}, \quad |\vec{r}| = (x^2 + y^2 + z^2)^{1/2}$$

and  $\theta$  is the angle between these vectors. The angle  $\theta$  is usually  $0^\circ$  when a radial line to the effective source is parallel to the earth's field (for induced sources). This expression can be used by itself expressing  $\theta$  in terms of the coordinates and gradients or by equating

$$|\Delta T| |\vec{r}| \cos \theta = -n T$$

and, as before, solving for x, z and n.

**Gradient Vector Diagrams and Vector Information from Total Field**

Of interest to those who prefer graphical methods for expressing magnetic profile data, consider again the expressions above, but only with respect to the magnitudes. If one assumes either a two-dimensional (infinitely long) anomaly or a traverse over a 3-dimensional source,

where in either case  $\frac{\partial F}{\partial y} = 0$  and/or  $y = 0$ , then the profiles for  $\frac{\partial T}{\partial z}$  and  $\frac{\partial T}{\partial x}$  would appear as in Figure 53. Inverting  $\frac{\partial T}{\partial z}$  and plotting in their respective directions, the relative magnitudes of each gradient taken directly from each curve, a set of gradient vectors and their vector sum can be obtained which is very analogous but not identical to, the component fields of an anomaly as are often observed using a vertical and horizontal intensity

magnetometer or dip needle. In the case of the total field magnetometer, however, the basic measurement is a scalar which, by itself, is easily and rapidly derived. The directional, or vector, requirements of the meter are derived as the gradient of the scalar with orientation requirements in terms of only several degrees. Conversely, the basic measurement of any component magnetometer involves slow, careful measurements to accuracies on the order of minutes of arc. Such vector diagrams, which are common in the literature over the last 3 decades, can be very usefully applied for a graphic (both literally and figuratively) presentation of a number of common geologic structures as sketched in figure 54 which many exploration personnel find very useful.

An interesting alternative method for obtaining vector or directional information from the inherently scalar total field magnetization is described in Chapter VI as a method for determining the direction of the field. The method employs simply the sensor, staff and a small (hard steel, slightly magnetized) needle all rigidly joined. As this arrangement is positioned at various directions, a maximum or minimum is observed precisely at the local earth's field direction. Realizing the difficulties, one may wish to affix a level bubble to such an arrangement to observe and plot the small change in dip of the earth's field in the vicinity of local anomalies particularly the larger anomalies. More sophisticated modifications to such a scheme would require audio display of the reading for rapid determination of a maximum or minimum reading or a coil system to modulate the field in a parallel or perpendicular direction.

(NOTE: VECTORS ARE TANGENTS TO GRADIENT LINES OF FLUX)

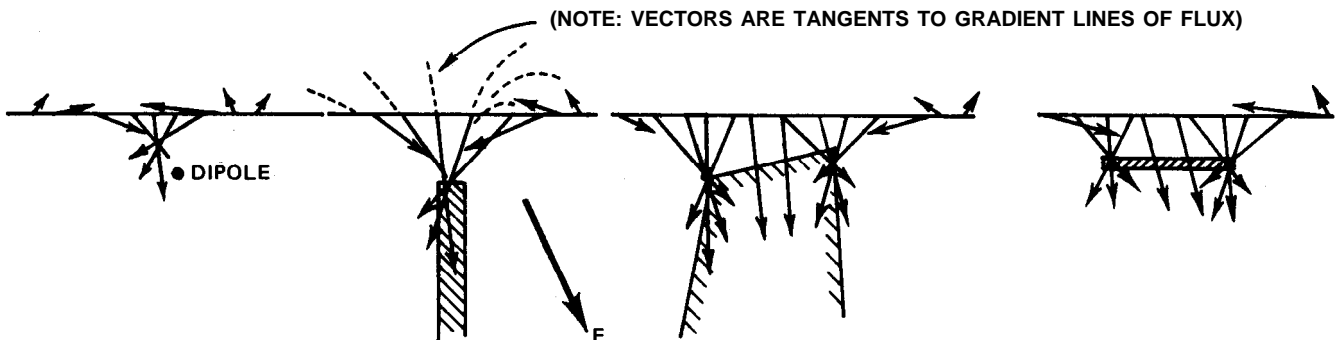

Figure 54. Gradient Vector Diagrams

## IX.

# MAGNETIC MEASUREMENTS OF ELECTRIC CURRENT DISTRIBUTIONS

### Introduction

The magnetic measurements described in Chapters I through VIII, by and large, concern anomalies due to various distributions of magnetite. The principal exceptions to this source of anomalies were certain sources of noise including the time variations of the field, electric trains and AC and DC power lines. It may therefore be obvious that electric currents, too, produce magnetic field perturbations measurable with a portable magnetometer. Such effects are important to consider from a standpoint of evaluating possible noise sources, establishing certain magnetic bias fields, object location using active currents and several other applications.

Among the current sources to be considered for these applications will be those due to a long wire, pair of parallel wires, conducting sheet, solenoid (or loop) and Helmholtz bias coil. In all cases in this chapter, it is only direct current (DC) that is considered in producing magnetic fields measurable with the magnetometer. Alternating current (AC) sources are not easily measured with the ordinary portable magnetometer and are only considered in light of their degrading effects on the proton precession signal.

### Applications

The estimation of the field produced by a given pair of parallel line sources may be used to estimate the effect of a nearby (or distant) DC train, tram, subway, or the newer extra-high-voltage DC power lines. A single line source can be used to locate buried pipelines or other conductors by applying the current to externally available points and following the suggestions given in Chapter VII. A sheet of current and its field is useful as an active method for mineral exploration. A solenoid or any other concentrated set of more-or-less circular windings is normally used to create a uniform field within the solenoid itself (as it is used, for example, in the proton magnetometer itself in the form of a solenoid or toroid, which is a solenoid whose ends are joined). A single solenoidal coil, however, produces an external field as well and produces a dipole magnetic moment identical to that created by a magnet except that the solenoid field can be varied at will in amplitude, sense and turned off as desired. Such a solenoid may be used for relocation under soil, rock or shallow water as previously described. Similarly, a solenoid can be placed in shafts, or boreholes and detected, regardless of conductivity, in adjacent holes when it is desired to obtain the approximate direction, distance and location of the former. Requirements for such location may arise in connection with the location of air shafts, connecting portions of a mine, access to mine workings, caves, lava tubes, or in the solution of other more esoteric problems.

Various configurations of coils can be constructed to produce a uniformly magnetic bias field for magnetic observatory use, measurement of magnetic properties of materials, cancelling or changing the direction of the earth's magnetic field or a variety of other purposes. Such coils are often in the shape of a large cube, sphere or different coaxial and orthogonal configurations, the simplest being the Helmholtz coil comprised of two identical coaxial coils spaced apart on their common axis at a distance equal to their radius. At the center of this arrangement is a relatively uniform field whose intensity is governed by the current in the coil.

A Helmholtz coil can be used with a total field magnetometer to obtain an accurate component measurement of the earth's field. If, for example, the coil is aligned with its axis vertical, the vertical component of the earth's field within the coil can be cancelled by generating an equal but opposite vertical field leaving only the horizontal component of the earth's field. A total field sensor within the coil then measures only the total field (now horizontal), and changes along this direction, i.e., it measures the horizontal component of the earth's field. Vertical components can be measured in a similar manner by switching coils and current appropriately.

As another application of the effect of electric currents on the earth's field, consider the measurement of the conductivity of the subsurface that would be of interest in geological exploration. As in many electrical methods for mineral exploration, electrodes of various configurations at spacings of hundreds of feet can be used to apply direct current into the ground for a period which overlaps the measurement time of the magnetometer. The magnetic field of the resulting current distribution can be measured and mapped with a portable total field magnetometer as an indirect means for mapping the subsurface conductivity (resistivity). Thus, a magnetometer, particularly one with higher sensitivity, say, 0.25 gamma, can be used for such a conductivity survey, rapidly, without orientation restrictions and without requiring contact with the ground surface. (NOTE: The current should be switched in polarity during consecutive readings at one location using the difference in readings as a measure of current density; the electrode array should be set up with consideration for the earth's field direction and the magnetometer can be used as well for conventional field measurements when the current is removed.)

### Configuration of Magnetic Field of Electric Current Sources

It will be assumed, as before, that the field of any current source is much smaller than the ambient field (except in the case of the Helmholtz bias field above)

and the total field magnetometer therefore measures only components of any current-produced field in the direction of the ambient field. The magnetic field of a single, long wire appears as in *figure 55* in the form of concentric circles about the wire in a direction following the 'right-hand-rule', i.e., the field will be in the direction of the curled fingers of the right hand when the current is in the direction of the thumb. Observe, for example, that a total field magnetometer will see no effect of the current in a wire parallel to the earth's field. Two long, straight, parallel wires with current flowing in opposite directions (the usual case) will produce fields which almost, but not quite, cancel at distances large compared to the separation of the wires. The configuration of the field, however small, will appear as a line of dipoles whose axes are at right angles to the plane of the two wires (see *Figure 55*).

A solenoid produces an external field identical to that from a small bar magnet in the same direction. The field lines of a solenoid and the approximate field of the Helmholtz bias coil are shown in *Figure 55*.

### Amplitude of Fields of Current Sources

The field of a single long wire is given by

$$T = 0.2i$$

where  $T$  is the anomaly in the direction of the earth's field in gauss (105 gammas = 1 gauss = 1 oersted),  $i$  is the current in amperes and  $r$  is the distance in centimeters between the wire and the point of measurement. The anomaly,  $T$ , as measured by a total field magnetometer would, again, be the component of  $T$  in the direction of the total field,  $F$ , paying special attention also to the configuration of the field of the wire.

A pair of infinitely long wires with current in opposite directions is

$$T_n = \frac{0.8di}{4r^2 + d^2}$$

at a point on a line from the midpoint between the wires where  $T_n$  is the anomaly in gauss,  $d$ , the separation of the wires in centimeters,  $r$ , the distance to the midpoint of the wires and,  $i$ , the current. The field at a point in the plane of the wires is

$$T_\theta = \frac{0.2 di}{r^2 + rd}$$

In the case where  $r \gg d$ , the field is the same for a given distance,  $r$ , in any direction from the wires and behaves as though it were a line of dipoles with amplitude

$$T = \frac{0.2di}{r^2}$$

As an example, consider an electric train at the magnetic equator in an E-W section of track, with several

locomotives drawing current from the circuit using a total of 2000 amperes, with the distance,  $d$ , between the overhead wire and its ground-rail-return of 500 centimeters and with a magnetometer at 1 kilometer (105 centimeters):

$$TF = T = \frac{0.2 \times 5 \times 10^2 \times 2 \times 10^3}{(10^5)^2} = 2 \times 10^{-5} \text{ gauss}$$

= 2 gammas

From the configuration of this field as shown in *Figure 55*, the effect of this train with a track in an N-S direction at the equator or in any direction at the north magnetic pole would be  $TF = 0$ , i.e., it would produce no effect on a total field magnetometer.

A conducting sheet carrying a current of density,  $i$  amperes per centimeter would produce a field,  $T$ , at right angles to the current flow above the sheet with the sense determined by the right hand rule. The current is

$$T = 0.2\pi i$$

where the intensity does not vary with distance from the sheet.

The external field of a solenoid can be expressed by

$$T = \frac{0.2 \pi a^2 Ni}{r^3}$$

where  $T$  is the field in gauss along the axis of the solenoid (one-half this value at the same distance at a point on a line normal to the axis of the solenoid),  $a$ , the radius of the solenoid,  $N$ , the number of turns, and the other terms as described. The field behaves as a dipole with all of the geometric characteristics described in Chapter V. For such a solenoid of an average radius of 2 centimeters with 500 turns carrying 0.1 ampere with its axis parallel to the field, the field at 50 centimeters E or W of the solenoid would be

$$T = \left(\frac{1}{2}\right) \frac{0.2 \times \pi \times 2^2 \times 5 \times 10^2 \times 0.1}{(50)^3} = 5 \times 10^{-4} \text{ gauss}$$

= 50 gammas

in a sense opposite to that of the solenoid itself.

A Helmholtz coil produces a field,  $T$ , at its center given by

$$T = \frac{0.899 Ni}{a}$$

where  $T$  is the field in gauss produced by the coil independent of the direction of the earth's field,  $a$ , the radius of the coils and the other terms as described above. More detailed information on the fields of coil systems, their homogeneity, etc., is available in publications of magnetic observatories.



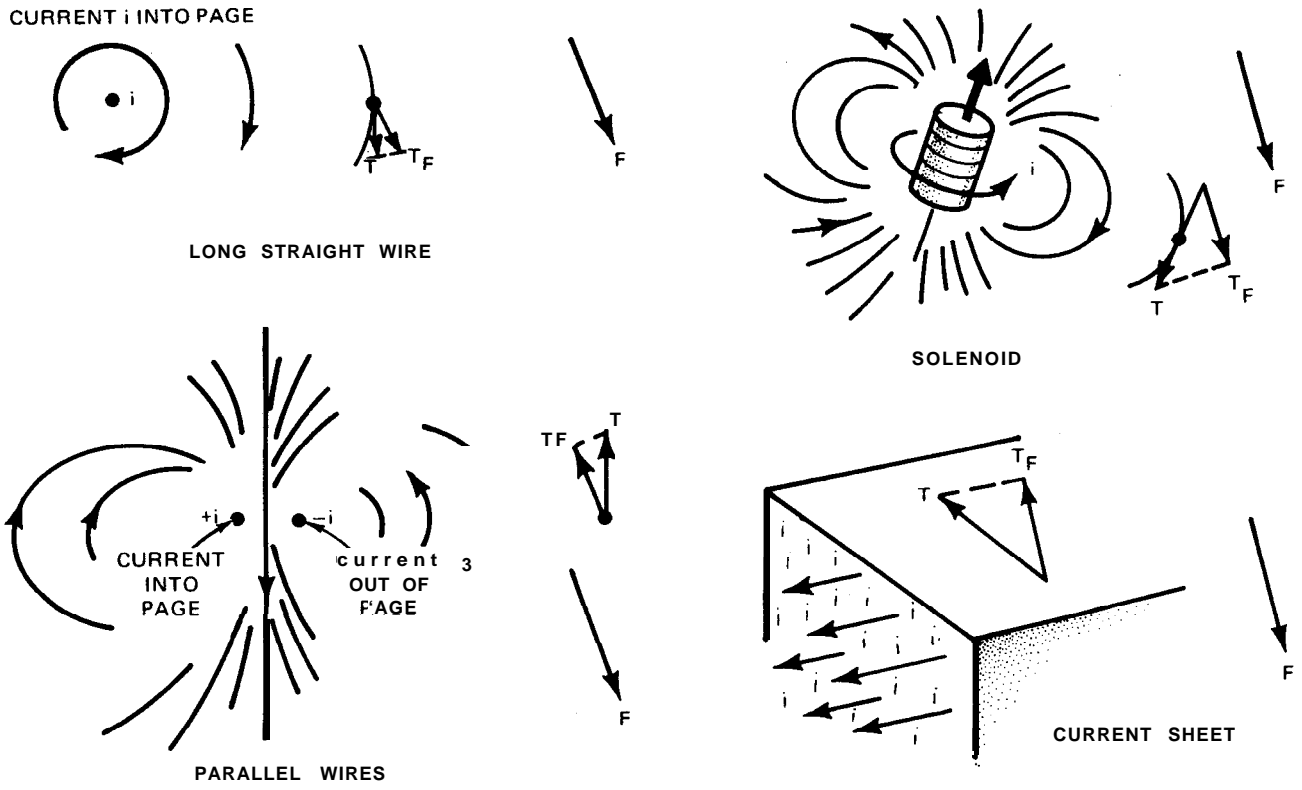

Figure 55. Configuration of Magnetic Field of Various Electric Current Sources

## REFERENCES

- Aitken, M.J., *Physics and Archaeology* Interscience, London, 1961.
- \_\_\_\_\_ *Archaeometry a quarterly journal of The Research Laboratory for Archaeology and the History of Art, Oxford University: Cambridge University Press, London.*
- Bossolasco, M., Editor *Pure and Applied Geophysics a quarterly journal: Birkhauser Verlag, Basel.*
- Bozorth, R. *Ferromagnetism :Van Nostrand, New York, 1951.*
- Chapman, S., and Bartels, J. *Geomagnetism ,Vol. I and II: Oxford University Press, London, 1940.*
- Dobrin, M.B., *introduction to Geophysical Prospecting McGraw-Hill, New York, 1960.*
- \_\_\_\_\_ *Geoexploration ,a quarterly journal: Elsevier, Amsterdam.*
- \_\_\_\_\_ *Geomagnetism and Geoelectricity a monthly journal: University of Tokyo.*
- \_\_\_\_\_ *Geophysical Case Histories Vol. I and II: Society of Exploration Geophysicists, Tulsa, 1948, 1956.*
- \_\_\_\_\_ *Geophysical Prospecting a quarterly journal: European Association of Exploration Geophysicists, The Hague.*
- \_\_\_\_\_ *Geophysics ,a bi-monthly journal: Society of Exploration Geophysicists, Tulsa.*
- Grant, F.S. and West, G.F., *Interpretation Theory in Applied Geophysics McGraw-Hill, New York, 1965.*
- Haalck, H., *Lehrbuch der Angewandten Geophysik Berlin, 1934.*
- Heiland, C.A., *Geophysical Exploration, afner, New York, 1940.*
- \_\_\_\_\_ *Izvestia, Series Geophysics a monthly journal: Academy of Sciences of the USSR, Moscow.*
- Jakosky, J.J., *Exploration Geophysics Trija, Los Angeles, 1957.*
- \_\_\_\_\_ *Mining Geophysics Vol. I and II: Society of Exploration Geophysicists, Tulsa, 1967.*
- Landsberg, H.E., editor *Advances in Geophysics Vol. 1-15: Academic Press, New York.*
- Morley, L.W., editor *Mining and Ground Water Geophysics Economic Geology Report No. 26: Department of Energy, Mines and Resources, Ottawa, 1970.*
- Nagata, T., *Rock Magnetism :Maruzen, Tokyo, 1961.*
- Nettleton, L.L., *Geophysical Prospecting for Oil McGraw-Hill, New York, 1940.*
- Parasnis, D.S., *Principles of Applied Geophysics John Wiley and Sons, New York, 1962.*
- \_\_\_\_\_ *Prospezioni Archaeologiche an annual journal: Leric Fondazioni, Rome.*
- Runcorn, S.K., editor *Methods and Techniques in Geophysics Interscience, N.Y., 1960.*
- \_\_\_\_\_ *Transactions, American institute of Mining and Metallurgical Engineers Geophysics, a journal: AIME, New York.*
- Vacquier, V., Steenland, N.C., and Henderson, R.G. *Interpretation of Aeromagnetic Maps Geological Society of America, Memoir No. 47: Geological Society of America, New York, 1951.*